

Plateau Series Outdoor Decorative Fireplace

Unit Dimensions:

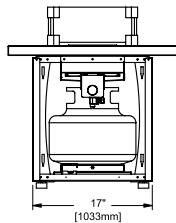

PTO30CFT

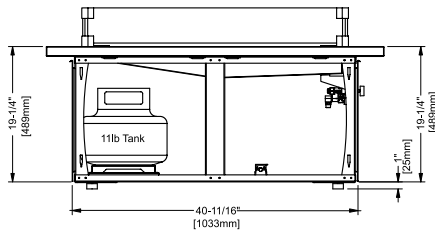
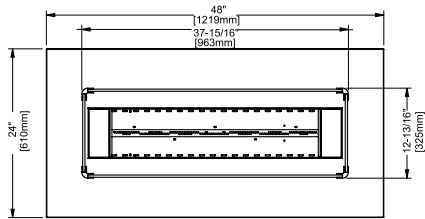
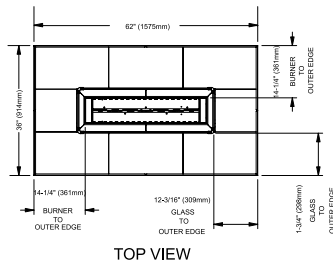

TOP VIEW

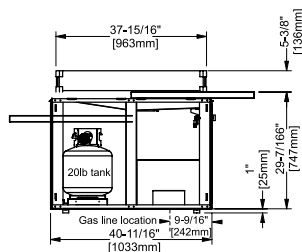

SIDE VIEW

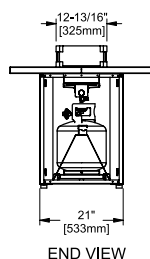

END VIEW

PTO30IST



Model	Plateau Series-NG2	Plateau Series-LP2
Fuel Type	Natural Gas	Propane Gas
Minimum Supply Pressure	5" W.C. (1.25 kPa)	12" W.C. (2.99 kPa)
Manifold Pressure - High	3.5" W.C. (0.87 kPa)	11" W.C. (2.73 kPa)
Manifold Pressure - Low	0.5" W.C. (0.12 kPa)	1" W.C. (0.25 kPa)
Orifice Size	#23 DMS	#45 DMS
Minimum Input Altitude 0-4500 ft.	18,000 Btu/h (5.27 kW)	15,000 Btu/h (4.39 kW)
Maximum Input Altitude 0-4500 ft.	49,000 Btu/h (14.36 kW)	48,000 Btu/h (14.06 kW)
Vent Sizing	No Vent	No Vent

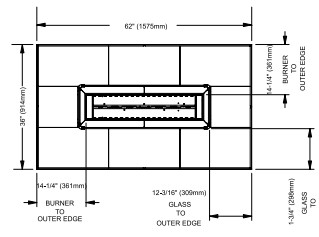

TOP VIEW

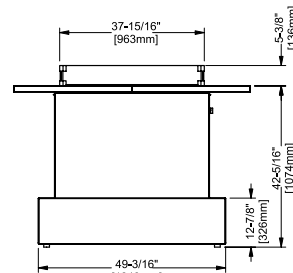

SIDE VIEW

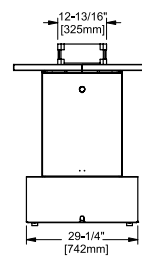

END VIEW

PTO30CKT

MINIMUM CLEARANCES TO COMBUSTIBLES

The clearances listed below are Minimum distances unless otherwise stated:

A major cause of fires is failure to maintain required clearances (air space) to combustible materials. It is of the greatest importance that this decorative gas appliance be installed only in accordance with these instructions.

Caution Requirements

The top, back and sides of the decorative gas appliance are defined by standoffs. The metal ends of the standoff may **NOT** be recessed into combustible construction.

WARNING

Fire hazard is an extreme risk if these clearances (air space) to combustible materials are not adhered to. It is of greatest importance that this decorative gas appliance be installed only in accordance with these instructions.

Plateau Series Clearance Requirements

Clearance:	Dimension	Measured From:
A: Back wall	17" (432mm)	Burner to back wall
B: Sidewall	17" (432mm)	Burner to sidewall
C: Ceiling	45" (1143mm)	Burner to Ceiling
D ¹ : Floor	0"	When using supplied leveling legs or optional casters.
D ² : Floor	1"(25mm)	Unit Base to Floor
E: Alcove Width	84"(2134mm)	Wall to Wall (Minimum)
F: Alcove Depth	60" (1524mm)	Front to Back Wall (Maximum)
Notes:	0"	No Hearth Required

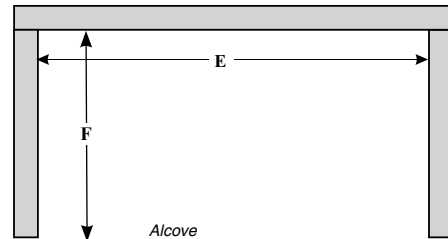
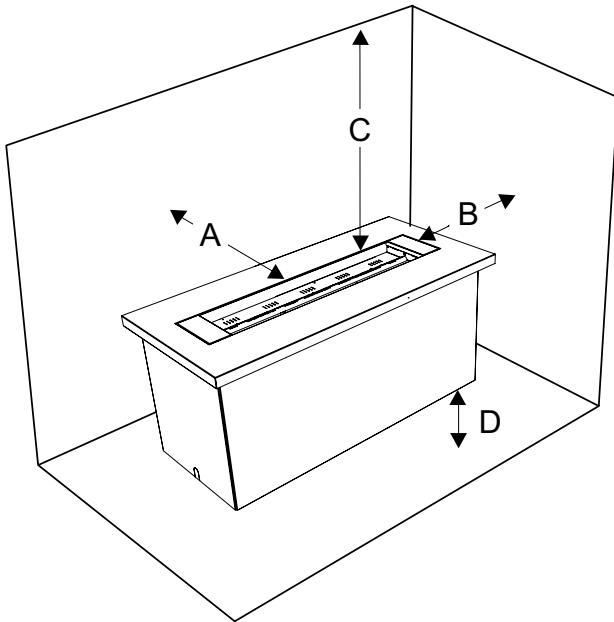

LOCATING YOUR OUTDOOR DECORATIVE GAS APPLIANCE

- 1) When selecting a location for your outdoor decorative gas appliance, ensure that the clearances are met.
- 2) This appliance must be installed in an open-air situation with natural ventilation, without stagnant areas, where gas leakage and products of combustion are rapidly dispersed by wind and natural convection.
- 3) Certain materials or items, when placed under or near the appliance, will be subjected to radiant heat and could become damaged.
- 4) Typically an outdoor space is not enclosed but, any enclosure in which the appliance is used shall comply with one of the following:

An enclosure with walls on all sides, but at least one permanent opening at ground level and no overhead cover.

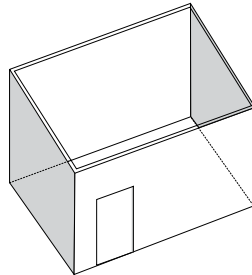

Within a partial enclosure that includes an overhead cover and no more than two walls.

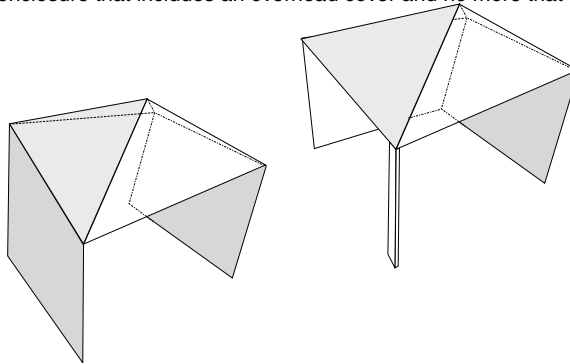

Within a partial enclosure that includes an overhead cover and more than two walls, the following shall apply:

- At least 25% of the total wall area is completely open, and
- At least 30% of the remaining wall area is open and unrestricted

30% or more in total of the remaining wall area is open and unrestricted.

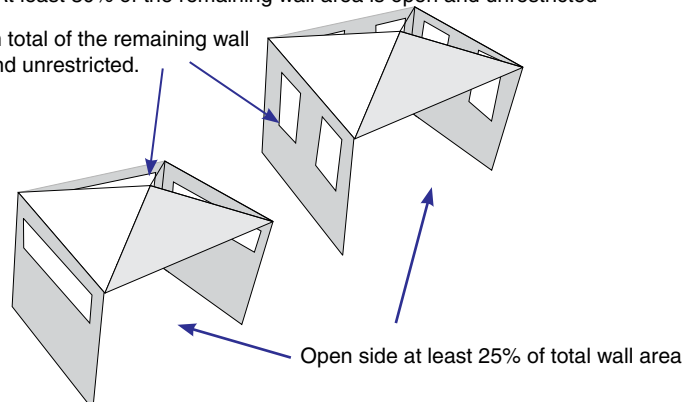



Oobadiyah's

1-800-968-8604

WOODSTOVES

Serving you online since 1999