



*THE SMARTEST
WOOD STOVE
YOU'LL EVER USE*



ADVENTURE SERIES
STEEL WOOD STOVES

QUADRA-FIRE[®]
NOTHING BURNS LIKE A QUAD

QUADRA-FIRE®

PERFORMANCE FROM THE BEGINNING



In 1990, the U.S. Environmental Protection Agency (EPA) enacted stringent wood-burning regulations, crippling the more than 500 wood stove manufacturers around the country. But not Quadra-Fire.

Two years of research and development later, founders Alan Trusler and Dan Henry unveiled their patented "Quad Burn" system. The technology produced powerful and efficient rolling flames so intense, it dawned the inception of the Quadra-Fire name.

WHY QUADRA-FIRE

For more than 30 years, Quadra-Fire has put performance and easy operation above all else. Today these ideals are vibrant and alive, blending our past with our present. Quadra-Fire products are proudly built to last by our members.

WHY WOOD

IT'S RENEWABLE - Using renewable energy sources is more important than ever and wood is 100 percent renewable. When you burn wood, you are also completing the last step of the natural carbon cycle of trees, resulting in a zero net carbon impact on the environment.

IT'S COST-EFFECTIVE - Heating with wood costs less than heating with electricity, liquid propane or heating oil, especially if you harvest wood yourself.

As the fire ignites, it remains clear:
NOTHING BURNS LIKE A QUAD.



COVER: ADVENTURE III SHOWN WITH
SATIN NICKEL DOOR AND HINGE PINS

ADVENTURE SERIES

THE SMARTEST WOOD STOVE YOU'LL EVER USE

Introducing Quadra-Fire Adventure Series steel wood stoves, equipped with Smart Burn Technology™ (SBT). The only stoves that deliver on:

PERFORMANCE

- SBT delivers controllable, efficient heat and a clean burn
- Reduces your home heating cost by up to 50%

EASY OPERATION

The only stove with SBT that:

- Maintains the temperature of your room with a programmable wall thermostat
- Automatically adjusts your stove, eliminating all manual air controls
- Tells you when to add more wood
- Allows you to load the wood, light the fire and walk away



EXCLUSIVE TECHNOLOGIES

Innovative technology is at work in every Quadra-Fire. These advancements make it possible to burn wood more effectively, efficiently, and with more control.

SMART BURN TECHNOLOGY

SBT maintains the temperature of your room with a programmable thermostat while automatically adjusting your stove's air control.

1. PROGRAMMABLE THERMOSTAT

Maintains the temperature of your room.



2. SBT ACTIVATION BUTTON

Eliminates all manual air controls and tells you when to add more wood.

3. CONTROL BOARD

Automatically adjusts the heat output level.

4. THERMOCOUPLES

Provides control board with temperature readings.

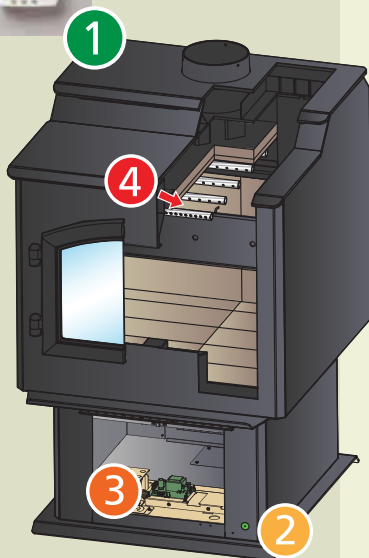

FOUR-POINT BURN SYSTEM

The patented Quadra-Fire Four-Point Burn System produces intense rolling flames. Four combustion cycles extend the heat, enhance the fire and increase efficiency for long-lasting, proven performance.

1. PRECISION START-UP

Airflow quickly routes to the heart of the fire.

2. SECONDARY BURN ZONE

Air movement helps create rolling flames and keeps the glass clean.

3. TERTIARY BURN ZONE

Superheated air ignites flammable gases rising from the wood.

4. QUATERNARY BURN ZONE

Remaining impurities are burned above the baffle before exiting up the chimney.

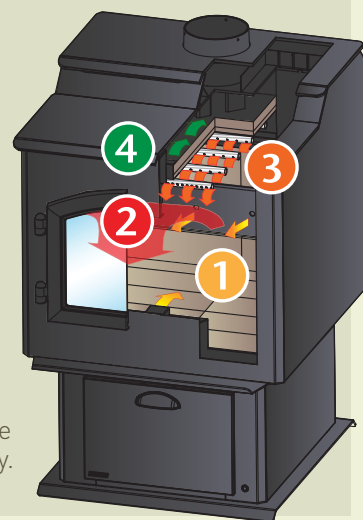

ADVENTURE III



Programmable Thermostat



SBT Activation Button

ARCHED DOOR WITH SATIN NICKEL TRIM AND SATIN NICKEL HINGE PINS

Peak BTU/Hr Output ¹ 98,100	Heating Capacity ² 1,500-4,000 sq. ft.	Max. Burn Time ³ 40 hrs	Efficiency ⁴ 75.5%	Emissions 2.9 g/hr	Firebox 4.5 cu. ft.	Recommended Log Length 24"	Viewing Area 188 sq. in.	Actual Weight 630 lbs.
--------------------------------------------------	-------------------------------------------------------------	----------------------------------------------	-----------------------------------------	------------------------------	-------------------------------	--------------------------------------	------------------------------------	----------------------------------

ADVENTURE II



Programmable Thermostat



SBT Activation Button

SHOWN WITH ARCHED DOOR IN BLACK

Peak BTU/Hr Output ¹ 61,700	Heating Capacity ² 1,200-3,300 sq. ft	Max. Burn Time ³ 20 hrs	Efficiency ⁴ 77.6%	Emissions 2.4 g/hr	Firebox 2.5 cu. ft.	Recommended Log Length 20"	Viewing Area 166 sq. in.	Actual Weight 510 lbs.
-----------------------------------------------------	---------------------------------------------------------------	----------------------------------------------	-----------------------------------------	------------------------------	-------------------------------	-----------------------------------------	------------------------------------	----------------------------------

ACCESSORIES

DOORS



ARCHED DOOR WITH SATIN NICKEL TRIM AND HINGE PINS

ADVENTURE II / III



ARCHED DOOR IN BLACK WITH SATIN NICKEL HINGE PINS

ADVENTURE II / III



ARCHED DOOR IN BLACK

ADVENTURE II / III



RECTANGULAR DOOR IN BLACK WITH SATIN NICKEL HINGE PINS

ADVENTURE II



RECTANGULAR DOOR IN BLACK

ADVENTURE II

FAN WITH RHEOSTAT



ADVENTURE II / III

ADVENTURE SERIES COMPARISON

ADVENTURE III		ADVENTURE II	
PEAK BTU/HR OUTPUT¹	» 98,100	PEAK BTU/HR OUTPUT¹	» 61,700
HEATING CAPACITY²	» 1,500-4,000 sq ft	HEATING CAPACITY²	» 1,200-3,300 sq ft
MAX. BURN TIME³	» 40 hrs	MAX. BURN TIME³	» 20 hrs
EFFICIENCY⁴	» 75.5%	EFFICIENCY⁴	» 77.6%
EMISSIONS	» 2.9 g/hr	EMISSIONS	» 2.4 g/hr
FIREBOX	» 4.5 cu ft	FIREBOX	» 2.5 cu ft
RECOMMENDED LOG LENGTH	» 24"	RECOMMENDED LOG LENGTH	» 20"
VIEWING AREA	» 188 sq in	VIEWING AREA	» 166 sq in
ACTUAL WEIGHT	» 630 lbs.	ACTUAL WEIGHT	» 510 lbs.

CLEARANCES TO COMBUSTIBLES

INSTALLATION CLEARANCE		A	B	C	D	E	F	G
Adventure III	Single Wall Pipe	17-1/2"	11-1/2"	32-1/2"	20"	8"	22-1/2"	42"
	Double Wall Pipe	15-1/2"	9-1/2"	29-1/2"	16"	4"	18-1/2"	42"
Adventure II	Single Wall Pipe	17-1/2"	11"	26-1/2"	14"	5-1/2"	18-1/2"	42"
	Double Wall Pipe	15-1/2"	9"	24-1/2"	12"	4"	16-1/2"	42"

Backwall / Sidewall

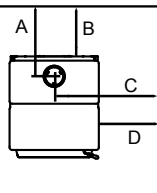

Corner Installation

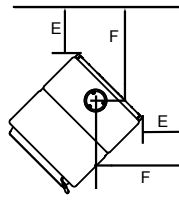

Stove to Ceiling Clearance

Follow pipe manufacturer's clearances as required

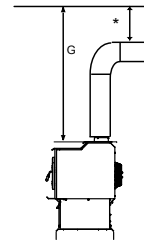

HEARTH PROTECTION

	A	B	C	D	E	F	G	H	I	J	K	L
Adventure III ⁵	8"	16"	33-5/8"	44-1/2"	4"	56-7/8"	33-1/8"	63-5/8"	8"	60-7/8"	37-1/8"	69-3/8"
Adventure II ⁵	8"	16"	31-5/8"	41-1/4"	4"	53-1/8"	30-3/4"	59-1/4"	5-1/2"	54-5/8"	32-1/4"	61-3/8"

Standard Dimensions

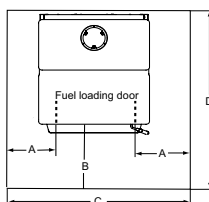

Corner Dimensions w/ Double Wall Pipe

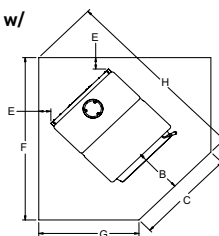

Corner Dimensions w/ Single Wall Pipe

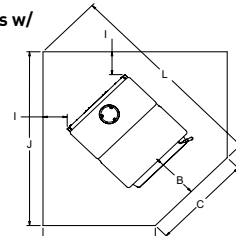



Thank you from everyone at Quadra-Fire

QUADRA-FIRE®

NOTHING BURNS LIKE A QUAD

www.quadrafire.com | 800-926-4356

[facebook.com/QuadraFire](https://www.facebook.com/QuadraFire) twitter.com/QuadraFire [youtube.com/QuadraFirePower](https://www.youtube.com/QuadraFirePower)

Available From:

Limited Lifetime Warranty⁶

The strongest in the industry, Quadra-Fire provides a limited lifetime warranty on the most important aspects: firebox and heat exchanger.

1: BTUs: 1st hour output uses high burn efficiency number. BTUs will vary depending on the type of fuel used and moisture content of the fuel. **2:** Heating capacity (in square feet) is a guideline only and may differ due to climate, building construction and condition, amount and quality of insulation, location of the heater, and air movement in the room. **3:** Actual burn times will vary based on how the appliance is operated, load size, moisture content and type of wood used, chimney height and installation. **4:** Weighted average LHV (low heating value) efficiency. **5:** Type I (ember) floor protector. **6:** For full warranty details go to www.quadrafire.com.

IMPORTANT - READ BEFORE YOU INSTALL! - Refer to the Owner/Installation Manual for complete clearance requirements and specifications. The images and descriptions in this brochure are provided to assist you in product selection only.

Quadra-Fire is a registered trademark of Hearth & Home Technologies. Product specifications and pricing subject to change without notice.

Fireplace, stove and insert surfaces get extremely HOT and can cause burns if touched. Keep a safe distance away. To learn more visit www.quadrafire.com/fireplacesafety