

PRODUCT SPECIFICATIONS

KHLDV400 Marquis Direct Vent System



GLASS VIEWING AREA

32"W x 30"H (960 Square Inches)

TECHNICAL INFORMATION

Max. Btu Input: 40,000 BTU/HR

Ignition System: Standing Pilot or Signature Command™ System

Gas Type: Natural or LP

Flue Type: Simpson Dura-Vent, Selkirk Metalbestos, MetalFab

Termination: Top vent

Clearance to Flue for interior: 3" Top, 1" Bottom and Sides

Clearance to Flue for Outside Wall: 1"

Clearance to Fireplace: 1"

Minimum Vent Height Before Elbow: 24"

FIELD INSTALLED ACCESSORIES

Standing Pilot Variable Thermostat Controlled Dual Forced Air Blower (160 cfm): BLOTKHLTD

Signature Command Dual Forced with Blower: BLOTKHLSC

Firebrick (required): Tavern Brown, Cottage Red, Olde English

Ambient Technologies™ Remote Controls and Thermostats

Andirons

Glass Doors (Decorative)

Field Conversion Kits

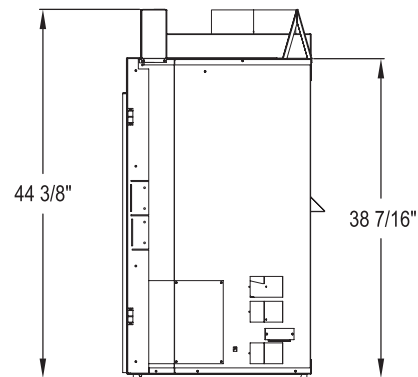
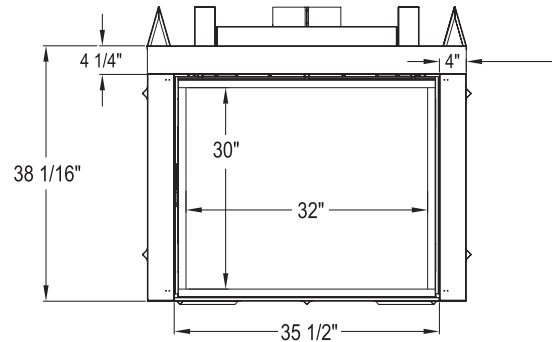
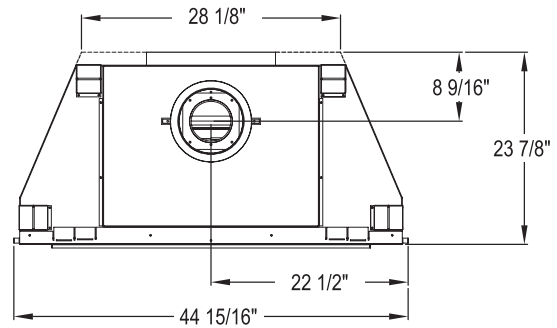

FRAMING DIMENSIONS

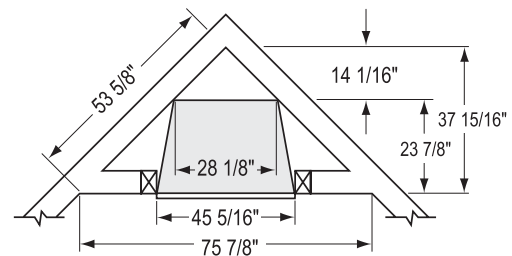

A Brand of Monessen Hearth Systems Co.
149 Cleveland Drive, Paris, Kentucky 40361
www.majesticproducts.com



To avoid personal injury or property damage, the product described by this brochure must be installed, operated and maintained in strict compliance with the instructions packaged with the product and all applicable building or fire codes. Contact local building or fire officials about restrictions and installation inspection requirements. All photographs and drawings on this brochure are for illustrative purposes