

CARE AND OPERATION INSTRUCTIONS

SLDVT Direct-Vent Gas Fireplaces

MODELS		MILLIVOLT:	ELECTRONIC:
SLDVT-30NM	SLDVT-40NM	SLDVT-30NE	SLDVT-35NE
SLDVT-30PM	SLDVT-40PM	SLDVT-40NE	SLDVT-45NE
SLDVT-35NM	SLDVT-45NM	SLDVT-45NE	
SLDVT-35PM	SLDVT-45PM		

WHAT'S INSIDE	
Table of Contents	2
Safety and Your Fireplace	2
FREE Safety Guard Offer (Protects Against Burns)	2
Important Safety Information	4
Attaching the Safety-in-Operation Warnings	5
[EN FRANÇAIS] L'information de sûreté importante	3-4
Apposition des mises en garde relatives à la sécurité d'utilisation	5
[EN ESPAÑOL] Información importante de seguridad	3-4
Colocación de advertencias de seguridad en operación	5



Intertek

Report No. 100353019PRT-001



INSTALLER: Leave this manual with the appliance.
CONSUMER: Retain this manual for future reference.
INSTALLATEUR : Laissez cette notice avec l'appareil.
CONSOMMATEUR : Conservez cette notice pour consultation ultérieure.

! WARNING / AVERTISSEMENT / AVISO

- HOT GLASS WILL CAUSE BURNS.
- DO NOT TOUCH GLASS UNTIL COOLED.
- NEVER ALLOW CHILDREN TO TOUCH GLASS.



- UNE SURFACE VITRÉE CHAUDE PEUT CAUSER DES BRÛLURES.
- LAISSER REFROIDIR LA SURFACE VITRÉE AVANT D'Y TOUCHER.
- NE PERMETTEZ JAMAIS À UN ENFANT DE TOUCHER LA SURFACE VITRÉE.

- EL VIDRIO CALIENTE CAUSARÁ QUEMADURAS.
- USTED DEBE NUNCA TOCAR EL VIDRIO CALIENTE.
- LOS NIÑOS DEBEN NUNCA TOCAR EL VIDRIO.

WARNING: If the information in these instructions is not followed exactly, a fire or explosion may result, causing property damage, personal injury, or death.

- Do not store or use gasoline or other flammable vapors and liquids in the vicinity of this or any other appliance.
- **WHAT TO DO IF YOU SMELL GAS:**
 - Do not try to light any appliance.
 - Do not touch any electrical switch; do not use any phone in your building.
 - Immediately call your gas supplier from a neighbor's phone. Follow the gas supplier's instructions.
 - If you cannot reach your gas supplier, call the fire department.
- Installation and service must be performed by a qualified installer, service agency or the gas supplier.

AVERTISSEMENT : Assurez-vous de bien suivre les instructions données dans cette notice pour réduire au minimum le risque d'incendie ou d'explosion ou pour éviter tout dommage matériel, toute blessure ou la mort.

- Ne pas entreposer ni utiliser d'essence ni d'autres vapeurs ou liquides inflammables dans le voisinage de cet appareil ou de tout autre appareil.
- **QUE FAIRE SI VOUS SENTEZ UNE ODEUR DE GAZ :**
 - Ne pas tenter d'allumer d'appareil.
 - Ne touchez à aucun interrupteur. Ne pas vous servir des téléphones se trouvant dans le bâtiment où vous trouvez.
 - Appelez immédiatement votre fournisseur de gaz depuis un voisin. Suivez les instructions du fournisseur.
 - Si vous ne pouvez rejoindre le fournisseur de gaz, appelez le service des incendies.
- L'installation et l'entretien doivent être assurés par un installateur ou un service d'entretien qualifié ou par le fournisseur de gaz.

Thank you for your purchase. We appreciate your business!
 Please carefully read and follow all instructions in this manual.
Pay special attention to all warnings and safety information.
 Following these safety, care, and operation instructions will help ensure many years of dependable and enjoyable service from your fireplace.

Register your product online today!

To help us keep you up-to-date on product information and offers, please take a few moments to register your product online at www.lennox.com (> Hearth > Owner Resources).

• FREE SAFETY GUARD OFFER •

The Lennox® **SAFETY GUARD** protects against severe burns and injuries by preventing direct contact with the front glass surface of your fireplace.

To receive your FREE **SAFETY GUARD**, call **1-800-786-7976** or visit www.lennox.com (> Hearth > Owner Resources).

Note: Safety Guards may not be available for some older models no longer in production.

Table of Contents

Safety and Your Fireplace **2**
Important Safety Information **4**
Attaching the Safety-in-Operation Warnings **5**
 Appliance Installation, Service, and Maintenance Notices 6
 Appliance Operation Notices 6
 Warranty Information 6
 General Information 7
 General Information 6
 Operation/Care of Your Appliance 8
 Gas Controls Access 8
 Variable Flame Adjustment 9
 Maintenance 10
 Front Glass Enclosure Panel, Removal and Installation 11
 Install Volcanic Stone, Embers and Logs 11
 Burner Flame Appearance/Sooting 16
 Burner Flame Adjustments 17
 Millivolt Appliance Checkout 17
 Electronic Appliance Checkout 17
 Replacement Parts 18
 Product Reference Information 18
 Wiring Diagrams 18
 Unit Shipping Weights/Volumes 19
 Accessory Components 19
 Lighting Instructions – Millivolt 22
 Lighting Instructions – Electronic 24
 Maintenance Schedule 26
 Troubleshooting Guide – Millivolt 27
 Troubleshooting Guide – Electronic 28
 Replacement Parts List 29



We recommend that our gas hearth products be installed and serviced by professionals who are certified in the U.S. by the National Fireplace Institute® (NFI) as NFI Gas Specialists.

Safety and Your Fireplace

All parts of your Lennox Hearth Products fireplace get EXTREMELY HOT!

- To prevent severe burns and injuries, install a screen or physical barrier to prevent direct contact with the glass.

To order a FREE Lennox® SAFETY GUARD for your fireplace, see details at left.

- Follow the safety instructions below and be sure everyone in your household understands this burn hazard:

- **The surfaces on your fireplace get EXTREMELY HOT!**

- **The glass on the front of the fireplace reaches EXTREMELY HIGH temperatures and can cause severe burns if touched.**



- **Keep children away from an operating fireplace. Closely supervise children in any room where a fireplace is operating to prevent contact with glass.**

- **Keep clothing, furniture, gasoline, and other flammable liquids away from the fireplace.**



- **Even after the gas is turned off, fireplace surfaces remain extremely hot.**

- Be sure to attach the enclosed **Safety-in-Operation Warnings** where you turn on your fireplace, to help remind everyone of the dangers associated with high temperatures (see page 5).

- Read **Important Safety Information** on page 4.

[FRENCH]

La sécurité et votre foyer

Toutes les parties de votre foyer Lennox Hearth Products deviennent EXTRÊMEMENT CHAUDES !

- Afin d'éviter de vous brûler gravement ou de vous blesser, installez une grille ou une barrière physique pour empêcher tout contact direct avec la vitre.

Pour commander un PANNEAU DE PROTECTION Lennox® GRATUIT pour votre foyer, consultez les détails dans la partie gauche.

- Suivez les instructions de sécurité ci-dessous et veillez à ce que tous les membres de votre famille soient conscients du danger de brûlure encouru :
 - **Les surfaces de votre foyer deviennent EXTRÊMEMENT CHAUDES !**
 - **La vitre située à l'avant du foyer atteint des températures EXTRÊMEMENT ÉLEVÉES et peut causer de graves blessures en cas de contact.**
 - **Tenez les enfants à l'écart du foyer lorsqu'il fonctionne. Surveillez attentivement les enfants dans les pièces où un foyer est utilisé afin d'éviter qu'ils ne soient en contact avec la vitre.**
 - **Tenez tous les vêtements, les meubles, l'essence et tout autre liquide inflammable à l'écart du foyer.**
 - **Même après fermeture du gaz, les surfaces du foyer restent extrêmement chaudes.**
- Veillez à coller les **Étiquettes de mise en garde relatives à la sécurité d'utilisation** à l'endroit où vous utilisez le foyer, pour rappeler à tous les utilisateurs les dangers liés aux températures élevées (**voir page 5**).
- Lisez la section **Informations importantes relatives à la sécurité**, page 4.

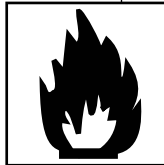

[SPANISH]

Seguridad y su chimenea

¡Todas las partes de la chimenea Lennox Hearth Products se ponen MUY CALIENTES!

- Instale una malla o barrera física para evitar el contacto directo con el vidrio y prevenir las quemaduras y lesiones graves.

Ver los detalles a la izquierda para ordenar un Lennox® SAFETY GUARD GRATIS para su chimenea.

- Siga las instrucciones de seguridad a continuación y asegúrese de que todos en su hogar sepan acerca de este peligro de quemadura:
 - **¡Las superficies de la chimenea se ponen MUY CALIENTES!**
 - **El vidrio delante de la chimenea alcanza temperaturas EXTREMADAMENTE ALTAS y puede causar quemaduras graves si se toca.**
 - **Mantenga a los niños alejados de la chimenea en funcionamiento. Supervise en forma cercana a los niños en cualquier cuarto donde haya una chimenea funcionando para impedir el contacto con el vidrio.**
 - **Mantenga la ropa, mobiliario, gasolina y otros líquidos inflamables alejados de la chimenea.**
 - **Aún después de haber apagado el gas, las superficies de la chimenea permanecen extremadamente calientes.**
- Asegúrese de colocar las **Etiquetas de advertencia de seguridad de operación** en el lugar donde enciende la chimenea, para que todos recuerden los peligros asociados con las altas temperaturas (**ver la página 5**).
- Lea la **Información importante** de seguridad en la **página 4**.

Important Safety Information

- 1. WARNING: Do not operate appliance with the glass front removed, cracked or broken. Replacement of the glass should be done by a licensed or qualified service person .**
- 2. Do not use this appliance if any part has been under water. Immediately call a qualified service technician to inspect the appliance and to replace any part of the control system and any gas control which has been under water.**
- 3. Due to high temperatures, the appliance should be located out of traffic and away from furniture and draperies.**
- 4. Children and adults should be alerted to the hazards of high surface temperature and should stay away to avoid burns or clothing ignition.**
- 5. Clothing or other flammable material should not be placed on or near the appliance.**
- 6. Young children should be carefully supervised when they are in the same room as the appliance. Toddlers, young children, and others may be susceptible to accidental contact burns. A physical barrier is recommended if there are at-risk individuals in the house. To restrict access to a fireplace or stove, install an adjustable safety gate to keep toddlers, young children, and other at-risk individuals out of the room and away from hot surfaces.**
- 7. Any safety screen or guard removed for servicing an appliance must be replaced prior to operating the appliance.**
- 8. Installation and repair should be done by a qualified service person. The appliance should be inspected before use and at least annually by a professional service person. More frequent cleaning may be required due to excessive lint from carpeting, bedding material, et cetera. It is imperative that control compartments, burners, and circulating air passageways of the appliance be kept clean. See maintenance instructions on page 10.**

L'information de sûreté importante

- 1. AVERTISSEMENT. Ne pas utiliser l'appareil si le panneau frontal en verre n'est pas en place, est craqué ou brisé. Confiez le remplacement du panneau à un technicien agréé**
- 2. Ne pas utiliser cet appareil s'il a été plongé, même partiellement, dans l'eau. Appeler un technicien qualifié pour inspecter l'appareil et remplacer toute partie du système de commande et toute commande qui a été plongée dans l'eau.**
- 3. En raison des températures élevées, l'appareil devrait être installé dans un endroit où il y a peu de circulation et loin du mobilier et des tentures.**
- 4. Les enfants et les adultes devraient être informés des dangers que posent les températures de surface élevées et se tenir à distance afin d'éviter des brûlures ou que leurs vêtements ne s'enflamment.**
- 5. On ne devrait pas placer de vêtements ni d'autres matières inflammables sur l'appareil ni à proximité.**
- 6. Les jeunes enfants devraient être surveillés étroitement lorsqu'ils se trouvent dans la même pièce que l'appareil. Les tout petits, les jeunes enfants ou les adultes peuvent subir des brûlures s'ils viennent en contact avec la surface chaude. Il est recommandé d'installer une barrière physique si des personnes à risques habitent la maison. Pour empêcher l'accès à un foyer ou à un poêle, installez une barrière de sécurité ; cette mesure empêchera les tout petits, les jeunes enfants et toute autre personne à risque d'avoir accès à la pièce et aux surfaces chaudes.**
- 7. Tout écran ou protecteur retiré pour permettre l'entretien de l'appareil doit être remis en place avant de mettre l'appareil en marche.**
- 8. L'installation et la réparation devrait être confiées à un technicien qualifié. L'appareil devrait faire l'objet d'une inspection par un technicien professionnel avant d'être utilisé et au moins une fois l'an par la suite. Des nettoyages plus fréquents peuvent être nécessaires si les tapis, la literie, et cetera produisent une quantité importante de poussière. Il est essentiel que les compartiments abritant les commandes, les brûleurs et les conduits de circulation d'air de l'appareil soient tenus propres. Voyez les instructions d'entretien à la page 10.**

[SPANISH]

Información importante de seguridad

- 1. ADVERTENCIA: No opere el artefacto con el frente de vidrio quitado, agrietado o roto. Un técnico de servicio licenciado o capacitado debe reemplazar el vidrio.**
- 2. No use este artefacto si alguna de sus partes ha estado bajo agua. Llame de inmediato a un técnico de servicio calificado para que inspeccione el artefacto y reemplace cualquier parte del sistema de control y cualquier control de gas que haya estado bajo agua.**
- 3. Debido a las altas temperaturas, el artefacto debe situarse fuera de las áreas de tráfico y lejos del mobiliario y cortinas.**
- 4. Se debe alertar a los niños y adultos sobre los peligros de las altas temperaturas en la superficie y que se mantengan alejados para evitar quemaduras o ignición de la ropa.**
- 5. No debe colocarse ropa u otros materiales inflamables sobre y cerca del artefacto.**

- 6. Se debe supervisar de cerca a los niños cuando estén en el mismo cuarto que el artefacto. Los niños pequeños, los jóvenes y otras personas pueden ser susceptibles a quemaduras por contacto accidental. Se recomienda instalar una barrera física si hay personas en riesgo en la casa. Para restringir el acceso a una chimenea o estufa, instale una puerta de seguridad ajustable para mantener a los niños pequeños, jóvenes y otras personas en riesgo fuera del cuarto y lejos de las superficies calientes.**
- 7. Cualquier malla o resguardo de seguridad quitado para dar servicio a un artefacto, debe reinstalarse antes de operar el artefacto.**
- 8. Una persona de servicio competente debe realizar la instalación y reparación. Una persona de servicio profesional debe inspeccionar el artefacto antes de usar al menos una vez por año. Se puede requerir limpieza más frecuente debido a la pelusa excesiva del alfombrado, del material de cobijas, etc. Es imprescindible mantener limpios los compartimientos de control, los quemadores y los pasajes de circulación del aire del artefacto. Ver las instrucciones de mantenimiento en la página 10.**

HOMEOWNER'S INSTRUCTIONS - ATTACHING-SAFETY-IN OPERATION WARNINGS

ATTACHING SAFETY-IN-OPERATION WARNINGS

Your fireplace has been furnished with safety instruction labels that are to be affixed to the operation and control point of the fireplace. A safety instruction label should be affixed to the wall switch plate where the fireplace is turned on and off (*See Figure A*) or wall thermostat (*See Figure B*) and if used on the remote control handheld transmitter (*Figure C*). The warnings should already have been put in place when the fireplace initial set-up was completed. If they are not affixed at these spots, locate the multi-lingual adhesive labels provided with these instructions and proceed as follows:

1. Locate the wall switch or wall thermostat that controls the fireplace (verify the switch operates the fireplace by turning it on and off). Clean the wall switch plate or wall thermostat thoroughly to remove any dust and oils. Affix the label to the surface of the plate of the wall switch that controls the fireplace (*Figure A*) or the wall thermostat (*Figure B*). Choose the language primarily spoken in the home.
2. If a remote control is used to control the fireplace, locate the transmitter and clean it thoroughly to remove any dust and oils. Affix the label to the surface of handheld transmitter (*Figure C*). Choose the language primarily spoken in the home.
3. If you are unable to locate the labels, please call Lennox Hearth Products or your nearest Lennox Hearth Products dealer to receive additional safety instruction labels free of charge.

Cat. No. H8024 Replacement Label Kit

LENNOX HEARTH PRODUCTS
1-800-9-LENNOX

Note: English is red text on clear label. French and Spanish are white text on black label.

SAFETY LABEL DIAGRAMS



Figure A



APPOSITION DES MISES EN GARDE RELATIVES À LA SÉCURITÉ D'UTILISATION

Votre foyer a été livré avec des étiquettes de sécurité qui doivent être collées à côté des dispositifs de contrôle du foyer. Une étiquette de sécurité doit être collée sur la plaque de l'interrupteur contrôlant l'allumage du foyer (*voir Figure A*) ou sur le thermostat mural (*voir Figure B*) et, le cas échéant, sur le boîtier de la télécommande (*Figure C*). Les mises en garde auraient dû être collées au moment de l'installation initiale du foyer. Si ce n'est pas le cas, prenez les étiquettes adhésives multilingues fournies avec ces instructions et procédez comme suit:

1. Repérez l'interrupteur ou le thermostat mural qui contrôle le foyer (vérifiez que l'interrupteur contrôle le fonctionnement du foyer en le faisant basculer de Marche à Arrêt, et vice-versa). Nettoyez soigneusement la plaque murale de l'interrupteur ou le thermostat mural pour éliminer la poussière et les traces de graisse ou d'huile. Collez l'étiquette sur la surface de la plaque de l'interrupteur mural qui contrôle le foyer (*Figure A*) ou du thermostat mural (*Figure B*). Choisissez la langue qui est principalement parlée dans la résidence du propriétaire.
2. Si une télécommande est utilisée pour contrôler le foyer, nettoyez la soigneusement pour éliminer la poussière et les traces de graisse ou d'huile. Collez l'étiquette sur le boîtier de la télécommande (*Figure C*). Choisissez la langue qui est principalement parlée dans la résidence du propriétaire.
3. Si vous ne trouvez pas les étiquettes, veuillez appeler Lennox Hearth Products ou votre distributeur Lennox Hearth Products local pour recevoir gratuitement des étiquettes supplémentaires.

Étiquettes de remplacement, n° cat. H8024

LENNOX HEARTH PRODUCTS
1-800-9-LENNOX

Remarque : Le texte anglais est rouge sur un support transparent. Le texte français et espagnol est blanc sur un support noir.

DIAGRAMMES DES ÉTIQUETTES DE SÉCURITÉ



Figure B



COLOCACIÓN DE ADVERTENCIAS DE SEGURIDAD EN OPERACIÓN

Su chimenea incluye etiquetas de instrucciones de seguridad que deben colocarse en el punto de operación y control de la chimenea. Se debe colocar una etiqueta de instrucciones de seguridad en la placa del interruptor de pared desde el cual se enciende y se apaga la chimenea (*ver la Figura A*) o en el termostato de pared (*ver la Figura B*) y en el transmisor de control remoto (*Figura C*) si se usa. Las advertencias ya deben haberse colocado cuando se completó la instalación inicial de la chimenea. Si no están colocadas en estos lugares, encuentre las etiquetas adhesivas multilingües proporcionadas con estas instrucciones y prosiga de la siguiente manera:

1. Identifique el interruptor o el termostato de pared que controla la chimenea (verifique que el interruptor opera la chimenea encendiéndola y apagándola). Limpie bien la placa del interruptor o el termostato de pared para quitar el polvo y aceite. Pegue la etiqueta en la superficie de la placa del interruptor que controla la chimenea (*Figura A*) o en el termostato de pared (*Figura B*). Seleccione el idioma que más se habla en la casa.
2. Si se usa un control remoto para controlar la chimenea, encuentre el transmisor y límpielo bien para quitar el polvo y aceite. Pegue la etiqueta en la superficie del transmisor (*Figura C*). Seleccione el idioma que más se habla en la casa.
3. Si no puede encontrar las etiquetas, sírvase llamar a Lennox Hearth Products o al distribuidor de Lennox Hearth Products más cercano para recibir etiquetas de instrucciones de seguridad adicionales gratuitas.

Juego de etiquetas de repuesto - N° de cat. H8024

LENNOX HEARTH PRODUCTS
1-800-9-LENNOX

Nota: La etiqueta en inglés es transparente con texto rojo. Las etiquetas en francés y español son negras con texto blanco.

DIAGRAMAS DE ETIQUETAS DE SEGURIDAD



Figure C



Appliance Installation, Service, and Maintenance Notices

IMPORTANT: Improper installation, adjustment, alteration, service, or maintenance can cause injury or property damage. Refer to this manual. For assistance or additional information, consult a qualified installer, service agency or the gas supplier.

Only trim kit(s) supplied by the manufacturer shall be used in the installation of this appliance.

Draft relief openings must not be covered or blocked.

These appliances must not be connected to a chimney or flue serving a separate solid fuel burning appliance.

Any change to this appliance and/or its operating controls is dangerous. Improper installation or use of this appliance can cause serious injury or death from fire, burns, explosion or carbon monoxide poisoning.

Carbon Monoxide Poisoning: Early signs of carbon monoxide poisoning are similar to the flu with headaches, dizziness and/or nausea. If you have these signs, obtain fresh air immediately. Turn off the gas supply to the appliance and have it serviced by a qualified professional, as it may not be operating correctly. Some people are more affected by carbon monoxide than others, including pregnant women, people with heart or lung disease or anemia, those under the influence of alcohol, and those at high altitudes.

Turn off gas and electrical power to the fireplace and allow it to cool before cleaning or servicing the appliance.

Appliance Operation Notices

Do not operate appliance with the glass front removed, cracked, or broken.

These fireplaces are vented gas appliances. Do not burn wood or other material in these appliances.

These fireplaces are designed as supplemental heaters. Therefore, it is advisable to have an alternate primary heat source when installed in a dwelling.

This appliance is only for use with the type of gas indicated on rating plate. This appliance is not convertible for use with other gases, unless a certified kit is used.

These appliances are designed to operate on natural gas or propane gas only. The use of other fuels or combinations of fuels will degrade the performance of this system and may be dangerous.

Provide adequate clearances around air openings and adequate accessibility clearance for service and proper operation. Never obstruct the front openings of the appliance.

Do not use this appliance if any part has been under water. Immediately call a qualified service technician to inspect the appliance and to replace any part of the control system and any gas control that has been under water.

The vent termination is hot while in operation and for a period of time following the use of the fireplace. To prevent contact with hot surfaces, we recommend the use of a termination guard. See *Page 18* for ordering information.

Warranty Information

Your gas appliance is covered by a limited twenty-year warranty. You will find a copy of the warranty accompanying this manual. Please read the warranty to be familiar with its coverage.

Retain this manual. File it with your other documents for future reference.

Failure to comply with the installation and operating instructions provided will result in an improperly installed and operating appliance, voiding its warranty.

Do not attempt to alter or modify the construction of the appliance or its components. Any modification or alteration may void the warranty, certification, and listings of this unit.

GENERAL INFORMATION

The fireplace models covered in this manual are direct-vent sealed combustion gas fireplace heaters designed for residential application. These direct-vent appliances operate with the combustion chamber completely isolated from the indoor environment.

All air for combustion is brought in from the outside and exhaust gases are vented through the same direct-vent, co-axial (intake/exhaust) vent system.

The **Millivolt** appliances have a millivolt gas control valve with piezo ignition system. If any optional accessories which require electrical power are being installed, the electrical power must be provided at the time of appliance installation.

The **Electronic** appliances have a battery backed-up electronic intermittent pilot system. No external electrical power is required to operate these appliances.

These appliances comply with National Safety Standards and are tested and listed by ETL/Intertek (Report No. 100353019PRT-001) to ANSI Z221.88 (in Canada, CSA-2.33), and CAN/CGA-2.17-M91 in both USA and Canada, as vented gas fireplace heaters.

The Installation must conform to local codes or, in the absence of local codes, with the National Fuel Gas Code, ANSI Z223.1/NFPA 54-latest edition, or the Natural Gas and Propane Installation Code, CAN/CSA B149.1-latest edition. The appliance, when installed, must be electrically grounded in accordance with local codes or, in the absence of local codes, the latest edition of the National Electrical Code, ANSI/NFPA 70, or the Canadian Electrical Code, CSA C22.1 - latest editions.

BTU Input

Millivolt and electronic models come standard with a manually-modulated gas valve; flame appearance and heat output can be controlled at the gas valve. The BTU inputs for these appliances are listed in **Table 1**.

Input (BTU/HR) Manually-Modulated Gas Valves (all models)		
Models	Input Rate (BTU / HR)	
	Nat. Gas	Prop. Gas
SLDVT-30	13,500 high 10,000 low	11,500 high 9,000 low
SLDVT-35	16,000 high 12,750 low	15,000 high 11,400 low
SLDVT-40	20,000 high 15,500 low	18,000 high 14,000 low
SLDVT-45	23,000 high 17,500 low	22,000 high 17,000 low

Table 1

Gas Pressure Requirements (All Models)

Gas pressure requirements are listed in **Tables 2 and 3**.

Test gauge connections are provided on the front of the millivolt gas control valve, identified IN for the inlet and OUT for the manifold side (see **Figure 3** on **Page 9**). A 1/8" NPT Test gauge connection is provided at the inlet and outlet (manifold) ports on the electronic gas control valve (see **Figure 4** on **Page 9**).

Inlet Gas Supply Pressure (all models)		
Fuel #	Minimum	Maximum
Natural Gas	4.5" WC (1.12 kPa)	10.5" WC (2.61 kPa)
Propane	11.0" WC (2.74 kPa)	13.0" WC (3.23 kPa)

Table 2

Manifold Gas Supply Pressure (all models)		
Fuel #	Low	High
Natural Gas	(Lo) 2.2" WC (0.55 kPa)	(Hi) 3.5" WC (0.87 kPa)
Propane	(Lo) 6.3" WC (1.57 kPa)	(Hi) 10.0" WC (2.49 kPa)

Table 3

These appliances must be isolated from the gas supply piping system (by closing their individual manual shut-off valve) during any pressure testing of the gas supply piping system at test pressures equal to or **less than** 1/2 psig (3.5 kPa).

These appliances and their individual shut-off valves must be disconnected from the gas supply piping system during any pressure testing of that system at pressures **greater than** 1/2 psig (3.5 kPa).

Burn-in Period

During the first few fires in this appliance, there will be some odor due to the curing of the paint and burning off of lubricants used in the manufacturing process. Depending on your use, the burn-in period may take a few hours or a few days.

KEEP YOUR HOUSE WELL VENTILATED DURING THE BURN-IN PROCESS. THE ODOR AND HAZE EMITTED DURING THE BURN-IN PROCESS CAN BE QUITE NOTICEABLE AND MAY SET OFF A SMOKE DETECTOR.

If an optional blower is installed, do NOT turn it on during the burn-in period.

Orifice Sizes (Sea Level to High Altitude – All Models)

These appliances are tested and approved for installations at elevations of 0-4500 feet (0-1372 meters) above sea level using the standard burner orifice sizes (marked with an asterisk (*) in **Table 4**).

For higher elevations, contact your gas supplier or qualified service technician.

Install the appliance according to the regulations of the local authorities having jurisdiction and, in the USA, the National Fuel Gas Code NFPA 54 / ANSI Z223.1 - latest edition or, in Canada, the CAN/CSA-B149.1 - latest edition.

Deration

At higher elevations, the amount of BTU fuel value delivered must be reduced by either using gas that has been derated by the gas company or by changing the burner orifice to a smaller size as regulated by the local authorities having jurisdiction and by the (USA) National Fuel Gas Code NFPA 54/ANSI Z223.1 - latest edition or, in Canada, the CAN/CSA-B149.1 - latest edition.

Burner Orifice Sizes Elevation 0-4500 feet (0-1372 meters)		
Model Series	Nat. Gas drill size (inches)	Propane drill size (inches)
SLDVT-30	#50 (0.070")* H4873•	#61 (0.039")* 35M91•
SLDVT-35	(0.0748")* H1355•	(0.045")* 75L10•
SLDVT-40	#44 (0.086")* 60J80•	(0.048")* 99K78•
SLDVT-45	(0.090")* 37L70•	#54 (0.055")* 99K79•

Table 4 * Standard size installed at factory.
• Part /Cat. Number.

IMPORTANT NOTE!

A white film may develop on the glass enclosure panel during the first few fires as part of the burn-in process.

The first few times you use the fireplace, clean the glass after each use (AFTER THE GLASS HAS COMPLETELY COOLED); otherwise, the white film will bake onto the glass and become difficult to remove.

See "Cleaning Glass" on **Page 10**.

OPERATION AND CARE OF YOUR APPLIANCE

⚠ WARNING

Young children should be carefully supervised when they are in the same room as the appliance. Toddlers, young children and others may be susceptible to accidental contact burns. A physical barrier is recommended if there are at risk individuals in the house. To restrict access to a fireplace or stove, install an adjustable safety gate to keep toddlers, young children and other at risk individuals out of the room and away from hot surfaces.

⚠ AVERTISSEMENT

Les jeunes enfants devraient être surveillés étroitement lorsqu'ils se trouvent dans la même pièce que l'appareil. Les tout petits, les jeunes enfants ou les adultes peuvent subir des brûlures s'ils viennent en contact avec la surface chaude. Il est recommandé d'installer une barrière physique si des personnes à risques habitent la maison. Pour empêcher l'accès à un foyer ou à un poêle, installez une barrière de sécurité; cette mesure empêchera les tout petits, les jeunes enfants et toute autre personne à risque d'avoir accès à la pièce et aux surfaces chaudes.

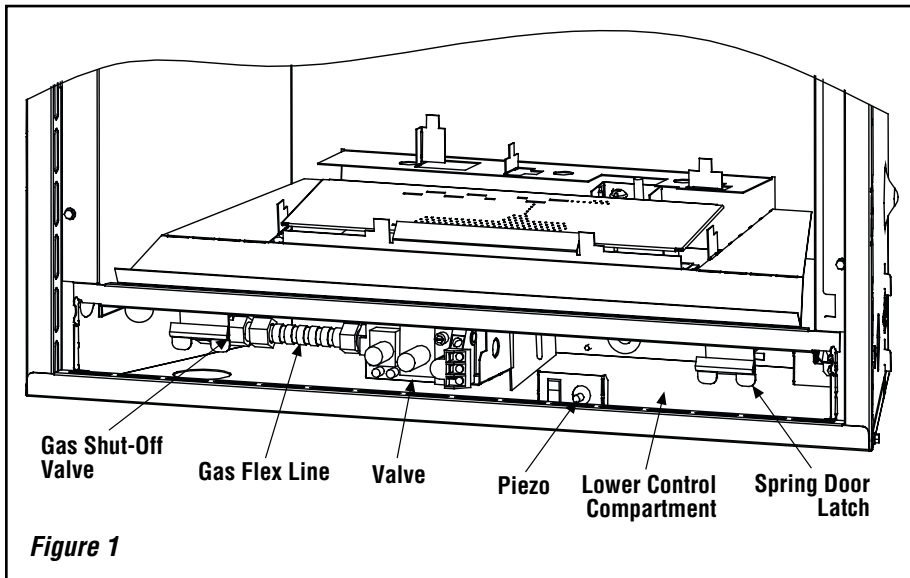
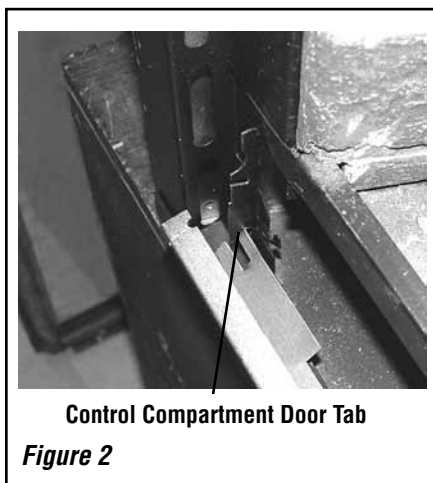

Figure 1



Control Compartment Door Tab

Figure 2

Gas Controls/Control Compartment Access

The gas controls can be found behind the control compartment access door.

Removing Control Compartment Door:

Open the panel by gently lifting it upward and forwards. Slide the door, first to one side and then the other, so the tabs clear both of the locating holes.

On millivolt systems, the piezo igniter, HI/LO flame adjustment knob, and pilot and main gas OFF/ON control knob are located below the glass panel enclosure. The gas valve for electronic systems is also located below the glass enclosure panel (see **Figure 1**).

Reinstalling Control Compartment Door:

To reinstall, insert the tabs on each side of the door into the corresponding holes in the control compartment opening, one side first then the other. To close, pull the door gently up and close by pushing forward and pushing the top edge down into the grooves at the brackets until it locks in place.

The standard controls for appliance operation are located behind the panel below the appliance front glass enclosure panel (**Figure 1**). Optional control switches are also available (see **Page 19 - Remote Wall Switch, Remote Control, Unit Mounted Rocker Switch or Wall Thermostat**).

Operation of millivolt and electronic gas control systems are different. Before lighting and operating your appliance determine if you have a millivolt or electronic appliance. Familiarize yourself with the gas control valve that your appliance uses. Refer to **Figure 1** for access to the gas control valve.

Millivolt Appliances - Appliances with Millivolt systems will be fitted with the gas control valve shown in **Figure 3**.

Electronic Appliances - Appliances with electronic systems will be fitted with the electronic valve shown in **Figure 4**.

Millivolt Appliances - To light millivolt appliances refer to **Figure 1**. Detailed lighting instructions are found on **Pages 22 and 23**. **Millivolt appliance lighting instructions may also be found on the pull out lighting instruction labels attached to the gas control valve.**

Once the pilot is lit, the main burner may be turned ON and OFF using wall switch, remote control, optional on unit rocker switch (FRS), or wall thermostat. To operate: Toggle the switch between its ON and OFF positions.

If your millivolt appliance is equipped with an optional remote switch kit (wall switch, remote control, rocker switch, or wall thermostat) and the pilot is lit, the appliance main burner may be turned on and off using the optional switch.

Note: To prevent excessive resistance in burner circuit (which can cause burner operation problems), only one burner control switch should be wired to valve.

Electronic Appliances

To light electronic appliances refer to the detailed lighting instructions found on **Pages 24 and 25** of these instructions. Electronic appliance lighting instructions may also be found on the pull out lighting instruction labels attached to the gas control valve.

If your electronic appliance is equipped with an optional remote wall switch or remote control kit the appliance main burner may be turned on and off with the wall switch or remote control.

If your electronic appliance is not equipped with a wall switch or remote control, the main burner must be turned off and on with a gas control switch located in some other location by the installer. Contact the installer for directions. Check batteries, if installed, routinely (ever three months).

TO LIGHT THE APPLIANCE DURING A POWER OUTAGE:

- Install batteries in battery pack.
- Turn unit mounted switch or wall switch to the ON Position.
- Unit should spark at pilot and light.
- Operate Normally.
- Replace batteries if needed.
- After power is restored, remove batteries.

Note: It is recommended that batteries not be installed in the battery holder until a power outage, or if the appliance is to be operated solely with two (2) "D" batteries.

Refer to the Lighting Instructions on **Page 24** to light the appliance in the event of a power failure.

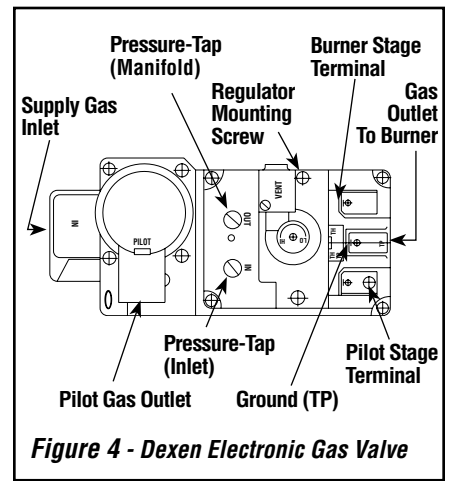
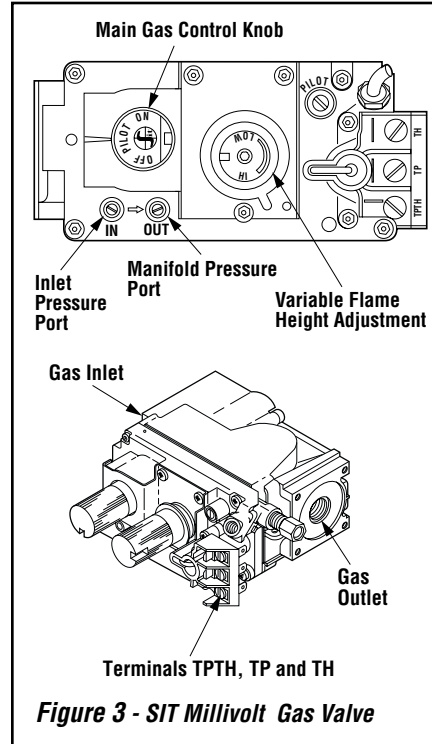

Variable Flame Height Adjustment

All millivolt and electronic appliances are equipped with a variable gas control valve. Flame height for these models may be adjusted through a range between fixed low and high settings while the appliance is in operation. Adjust the flame height as desired after lighting the appliance by rotating the variable adjustment control knob (HI/LO) located on the front of the valve (refer to **Figures 3 and 4**).

MAINTENANCE

(See Maintenance Schedule, Page 26)

Refer to the maintenance schedule for maintenance tasks, procedures, periodicity and by whom they should be performed. Always verify proper operation of the appliance after servicing.



WARNING

Turn off gas and electrical power to the fireplace and allow it to cool before cleaning or servicing the appliance.

CAUTION: Wear gloves and safety glasses for protection while doing required maintenance.

Verify proper operation after servicing.

S'assurer que l'appareil fonctionne adéquatement une fois l'entretien terminé.

Always turn off gas to the pilot (millivolt appliances) before cleaning. Before re-lighting, refer to the lighting instructions in this manual. Instructions are also found on a pull-out panel located in the control compartment.

Before re-lighting the fireplace, refer to the lighting instructions in this manual. Instructions are also found on pull-out panels located below the glass door in the control compartment.

Inspect Venting System

The appliance and venting system should be thoroughly inspected before initial use and at least annually by a qualified service technician (inspection should include ensuring that exhaust or intake passages are unobstructed and vent components are properly assembled and not damaged). **Homeowner must contact a qualified service technician at once if any abnormal condition is observed.**

If the venting system is disassembled for any reason, a qualified service technician should follow vent installation instructions for proper reassembly and proper sealing of the venting system components. However, more frequent periodic inspections and cleanings should be performed by the homeowner.

Cleaning Glass

(Also see *Front Glass Enclosure Panel, Removal and Installation* on Page 11).

Note: Clean glass after first two weeks of operation (after Burn-In period is over) and then only when necessary and only when the fireplace is cool. Wipe surface with clean, dampened, soft cloth. Follow with dry, soft towel as desired. Take care not to scratch the glass surface.

Clean the viewing glass periodically to remove any build-up caused from the following:

IMPORTANT: Do not use abrasive cleaners on glass. Never clean the glass when it is hot.

- During start-up, it is normal for condensation to form on the inside of the glass (this condensation and fog will usually disappear in a few minutes). The moisture can cause lint, dust and other airborne particles to cling to the glass surface.
- Initial curing of the high temperature paint and burning off of lubricants used in the manufacturing process may result in a film on the glass.
- A white coating may form on the glass as a result of impurities and minerals in the fuel.

It is recommended that the glass be cleaned two or three times during each heating season, depending on the circumstances present. The following cleaning solutions are approved for use to clean glass:

- Non-ammonia based household cleaner
- 50%-50% mix of white vinegar and water
- Gas fireplace/stove glass cleaner

Inspect Glass Gasket

Visually inspect the gasket on the backside of the glass enclosure panels. The gasket surface must be clean, free of irregularities and seated firmly.

Clean Control Compartment

Keep control compartment clean by vacuuming or brushing at least twice a year. More frequent cleaning may be required due to excessive lint from carpeting, bedding materials, etc. It is important that control compartments, burners and circulating air passageways of the appliance be kept clean.

Clean Logs And Burner

Carefully remove the logs (use care when handling the fiber logs, as they become quite fragile after curing). Vacuum out any foreign matter (lint, carbon, etc.) on the burner. Ensure the burner ports are "open." Remove any carbon deposits from the under side of the logs using a vacuum cleaner, or a soft bristled brush (i.e. paint brush).

Note: Improper positioning of logs can create carbon build-up and will alter the performance of the appliance.

Replacing Logs

If the logs become damaged by accident or improper handling and need replacement, use only the proper replacement logs from manufacturer (see Pages 13, 14 and 15 for ordering information).

Re-Install Embers and Logs

Carefully follow placement instructions on Pages 12 through 15. All logs should fit onto corresponding pins and/or log stoppers. This will ensure a proper flame and safe combustion.

Inspect Wiring

Refer to wiring diagrams on Page 18.

CAUTION: When servicing controls, label all wires prior to disconnection. Wiring errors can cause improper and dangerous operation. Verify proper operation after servicing.

ATTENTION: Au moment de l'entretien des commandes, étiquetez tous les fils avant de les débrancher. Des erreurs de câblage peuvent entraîner un fonctionnement inadéquat et dangereux.

Inspect and clean all wire connections. Ensure that there is no melting or damage. Inspection should include:

- Terminals at the Valve
- OFF/ON Switch
- (Optional Control Switch) Wall Thermostat, Remote Control or Remote Wall Switch Kit

Inspect Burner Flame Appearance

Ensure that the burner flame appearance resembles the flame shown in Figures 12, 13 and 14 and as described in *Flame Appearance and Sooting* on Page 16. The Homeowner must contact a qualified service technician at once if any abnormal condition is observed.

Small Area Paint Touch-up

The finish of the appliance is a high-quality powdercoat. Only use factory supplied powdercoat paint kit for touch-ups. Paint is available at your local authorized Lennox Hearth Products dealer. Never attempt to paint a hot fireplace.

Do not attempt to repaint the appliance until the finish is completely cured (see *Burn-In Period* on Page 7). If the surface later becomes stained or marred, it may be lightly sanded and touched up with spray paint.

Front Glass Enclosure Panel, Removal and Installation

⚠ WARNING

- Do not attempt to substitute the materials used on this door, or replace cracked or broken glass.
- Handle this glass with extreme care! Glass is susceptible to damage – Do not scratch or handle roughly while reinstalling the glass door frame.
- The glass door(s) of this appliance must only be replaced as a complete unit as provided by the manufacturer. Do not attempt to replace broken, cracked or chipped glass separately.
- Do not attempt to touch the front enclosure glass with your hands while the fireplace is in use.

⚠ WARNING

Do not operate appliance with the glass front removed, cracked or broken.

⚠ AVERTISSEMENT

Ne pas utiliser l'appareil si le panneau frontal en verre n'est pas en place, est craqué ou brisé.

⚠ WARNING

Any safety screen or guard removed for servicing the appliance must be replaced prior to operating the appliance.

⚠ AVERTISSEMENT

Tout écran ou protecteur retiré pour permettre l'entretien de l'appareil doit être remis en place avant de mettre l'appareil en marche.

Only doors certified with the appliance shall be used.

Seules des portes certifiées pour cet appareil doivent être utilisées.

CAUTION: DO NOT abuse glass door by striking or slamming shut.

These are direct-vent appliances. They are designed to operate only when the front glass enclosure panels are installed. Generally the front glass enclosure panel should not be removed except to gain access to the components within the firebox.

Removing Glass Enclosure Panels (see Figure 6)

1. To access the glass door securing latches, first open the lower control compartment door (Figure 6) by lifting and pulling the bottom panel forward.
2. Pull the latches forward and down to release them from the door channel.
3. Pull the bottom of the door out a few inches and grasp it on the right and left. Gently lift to release the door from its channel above the door. Pull the door forward.
4. Retrieve the glass door. Visually inspect the gasket on the backside of the frame. Gasket surface must be clean, free of irregularities and seated firmly.
5. Position the door in front of the firebox opening with the bottom of the door held away from the fireplace (Figure 6). Hook the top flange of the door frame over the top of the firebox frame.
6. Let the bottom of the door frame swing gently in towards the fireplace ensuring that the gasket seats evenly as the door frame draws shut. Fasten the two latches located underneath the firebox floor to the door's vee-flange. Close both the latches securely.
7. If desired, install the optional hood. Note the location of the three clips inside the top air channel above the door. The clips are equally spaced on the top surface of the air channel opening. Use a screwdriver to open the clips slightly if needed. Engage the back edge of the eyebrow into the clips to secure.

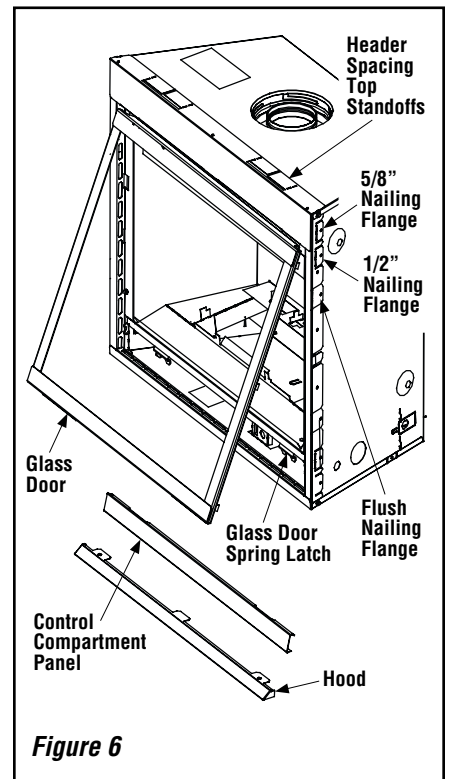

Figure 6

INSTALL VOLCANIC STONE, GLOWING EMBERS AND LOGS

NOTE: Turn off all electricity to the appliance before you install volcanic stone, embers and logs.

1. Remove the front glass enclosure panel (see Removing Glass Enclosure Panels on Page 11).
2. Always handle logs carefully to prevent breakage.
3. Install decorative volcanic stone - Sprinkle the decorative volcanic stone in a pleasing pattern (see Figure 7 on page 12). The volcanic stone should be placed directly on top of the firebox bottom, along the slope and to the back at the right and left sides of the burner. Position any ceramic fiber liners before placing the stone. Logs can be positioned after the volcanic stone.

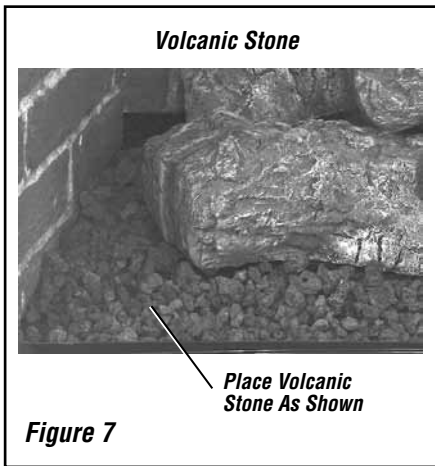

Figure 7

4. Placement of Glowing Embers -

Separate the Embers (rockwool) into pieces about the size of a quarter (see **Figure 8**). Keep the pieces fluffed up, not matted. Distribute these pieces over the surface of the burner, as shown in **Figures 9, 10 and 11**. Do not use more than is necessary. **Ensure that the main burner slots remain uncovered by the ember material.** Position the embers on the small holes of the ember bed area.

Note: This appliance is provided with enough Glowing Embers for several applications, do not use all that is in a new bag at one time. For best glowing effect, replace the ember material annually.

5. Placement of Logs -

All logs that have locating notches or slots to help ensure that they are properly positioned. All top logs that rest on lower logs, do so over notches, indents or nubs. Proper log placement is critical to prevent sooting. Logs should be placed in the gaps between the flame peaks and should be positioned so they do not impinge the flames.

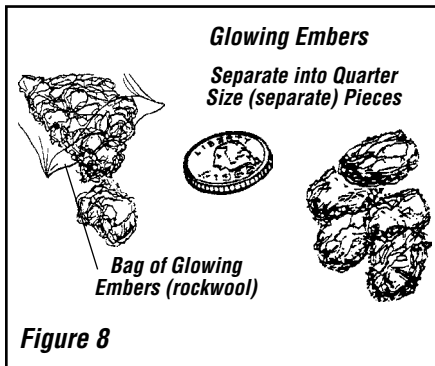

Figure 8

SLDVT-30 and 35 - Install the four logs as Follows:

Carefully position the ceramic fiber logs over the burner as shown in **Figure 9**. Logs should be placed in the order shown and per the following instructions.

1. Place the left front log (1) as shown. Position it on the two left front log brackets.
2. Place the right front log (2) as shown. Position it on the two right front log brackets.
3. Place the left rear log (3) as shown. Position it on the upper and lower left rear log brackets.
4. Place the right rear log (4) as shown. Position it on the right rear log bracket. Note that the hole on the bottom of the right rear log rests over the "Nub" on the right front log.

SLDVT-40 - Install the four logs and Ember Chunk as Follows:

Carefully position the ceramic fiber logs over the burner as shown in **Figure 10**. Logs should be placed in the order shown and per the following instructions.

1. Place the ember chunk (1) over the tab on the rear log support as shown.
2. Place the left front log (2) as shown. Position it on the two left front log brackets.
3. Place the right front log (3) as shown. Position it on the two right front log brackets.
4. Place the left rear log (4) as shown. Position it on the left rear log bracket.
5. Place the right rear log (5) as shown. Position it on the right rear log bracket. Note that the hole on the bottom of the right rear log rests over the "Nub" on the right front log.

SLDVT-45 - Install the five logs as Follows:

Carefully position the ceramic fiber logs over the burner as shown in **Figure 11**. Logs should be placed in the order shown and per the following instructions.

1. Place the left front log (1) as shown. Position the holes on the bottom of the log on the two left front log brackets.
2. Place the right front log (2) as shown. Position the holes on the bottom of the log on the two right front log brackets.
3. Place the center log (3) over the center and right rear log brackets as shown.
4. Place the left rear log (4) as shown. Position the holes on the bottom of the log on the left rear log brackets. Log also rests on center log (3).
5. Place the right rear log (5) as shown. Rest the bottom of the log over the groove on the center log.

! WARNINGS

- **DO NOT attempt to install the logs until the appliance installation has been completed, the gas line connected and tested for leaks and the initial burner operation has been checked out.**
- **The size and position of the log set was engineered to give the appliance a safe, reliable and attractive flame pattern. Any attempt to use a different log set in the fireplace will void the warranty and will result in incomplete combustion, sooting, and poor flame quality.**
- **Logs get very hot and will remain hot up to one hour after gas supply is turned off. Handle only when logs are cool. Turn off all electricity to the appliance before you install grate, volcanic stone, vermiculite, embers and logs.**
- **This appliance is not designed to burn wood. Any attempt to do so could cause irreparable damage to appliance and prove hazardous to your safety.**
- **If logs are not installed according to the log installation instructions, flame impingement and improper combustion could occur and result in soot and/or excessive production of carbon monoxide (CO), a colorless, odorless, toxic gas.**

REFERENCE Firebox Accessories / Parts		
Cat. No.	Model No.	Description
88L53	FGE	Bag of Glowing Embers
80L42	FDVS	Bag of Decorative Volcanic Stone

SLDVT-30 AND SLDVT-35 LOG PLACEMENT

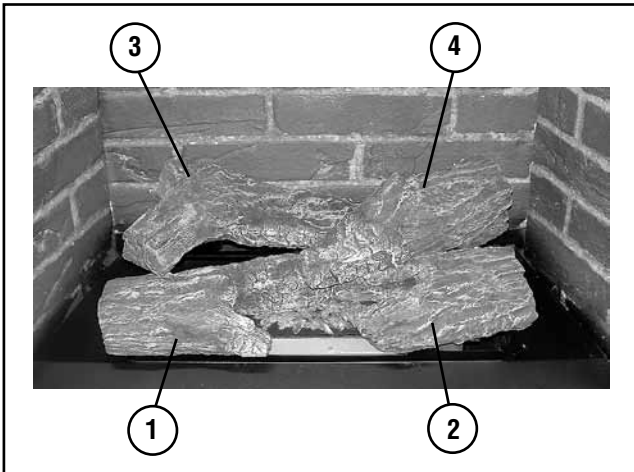

Log Number	Description
1	Left Front Log
2	Right Front Log
3	Left Rear Log
4	Right Rear Log

Catalog Number for the entire log set: H7244

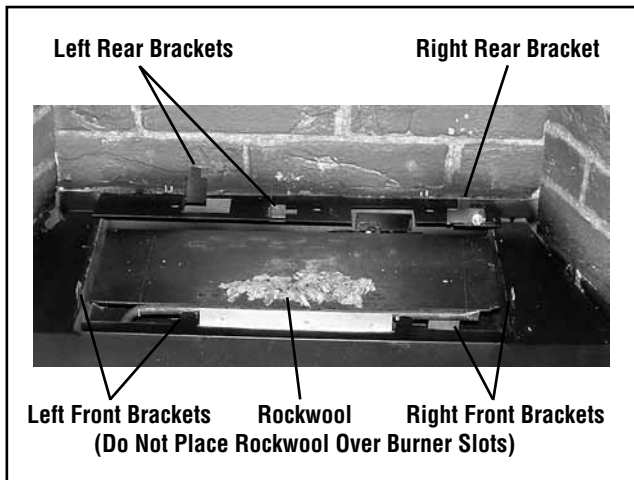

Step 1

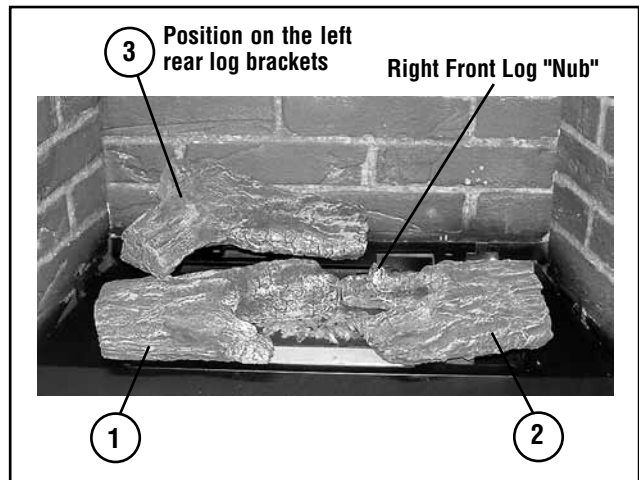

Step 3

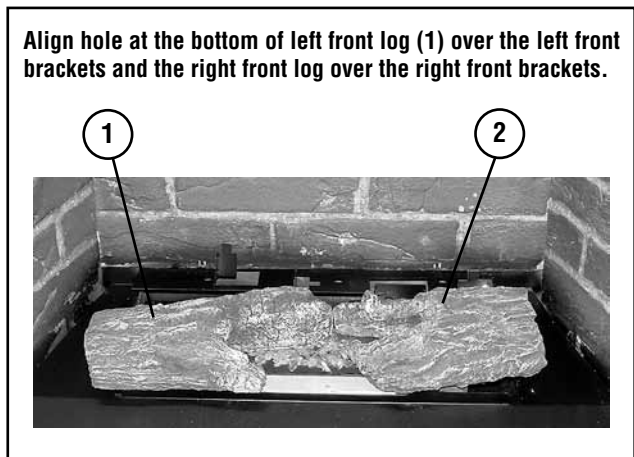

Step 2

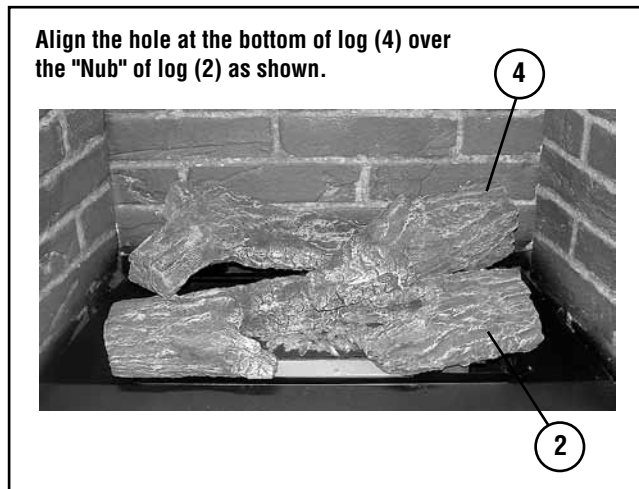

Step 4

Figure 9

SLDVT-40 LOG PLACEMENT

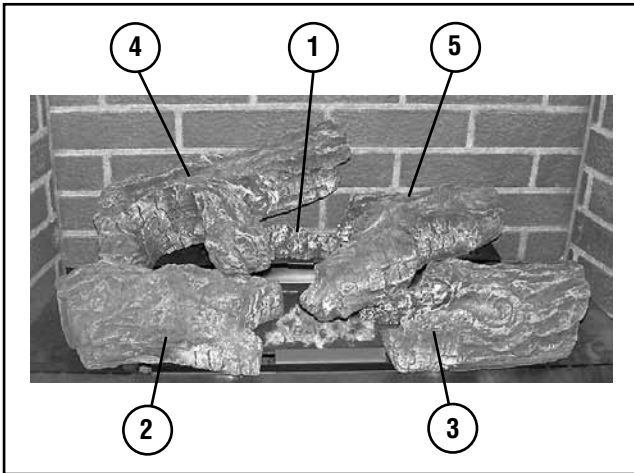

Log Number	Description
1	Ember Chunk
2	Left Front Log
3	Right Front Log
4	Left Rear Log
5	Right Rear Log

Catalog Number for the entire log set: H7245

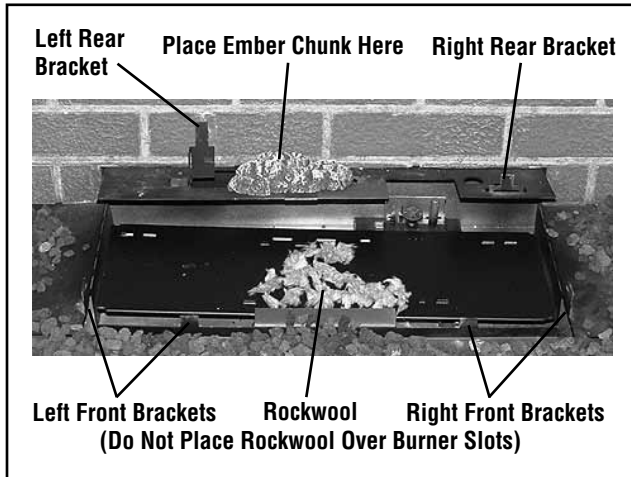

Step 1

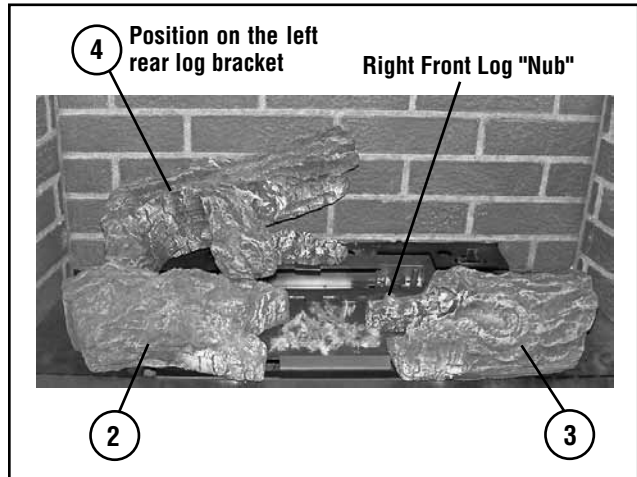

Step 3

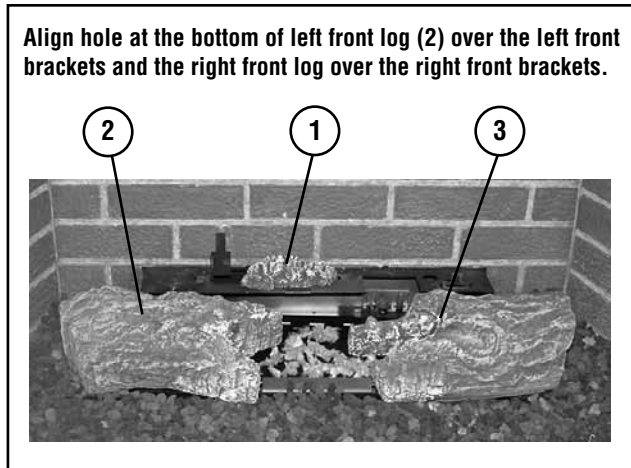

Step 2

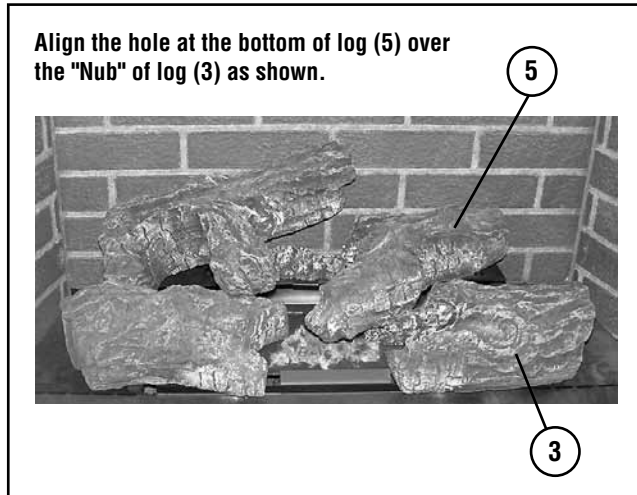

Step 4

Figure 10

SLDVT-45 LOG PLACEMENT

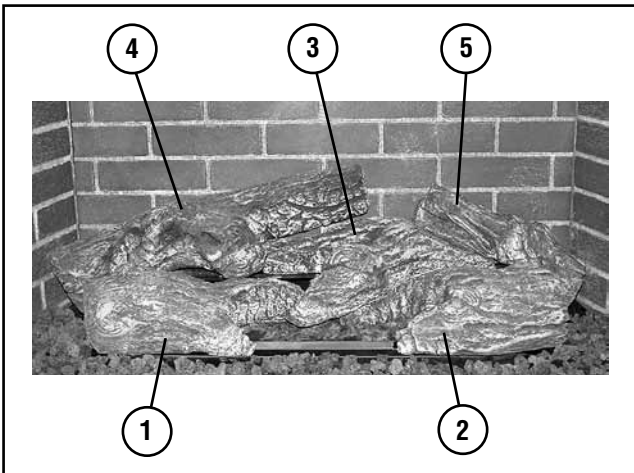

Log Number	Description
1	Left Front Log
2	Right Front Log
3	Center Log
4	Left Rear Log
5	Right Rear Log

Catalog Number for the entire log set: H7547

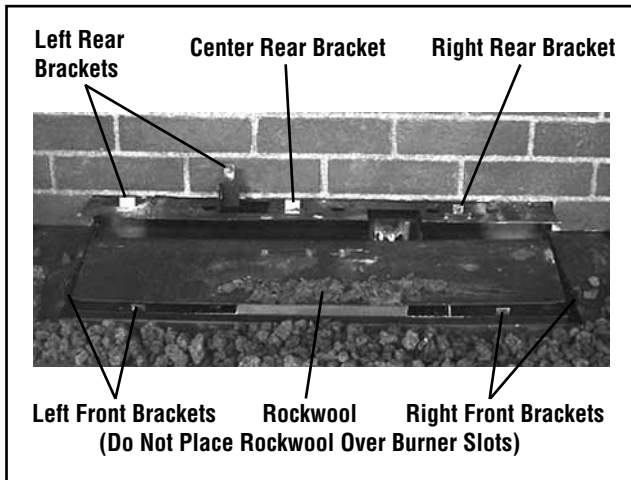

Step 1

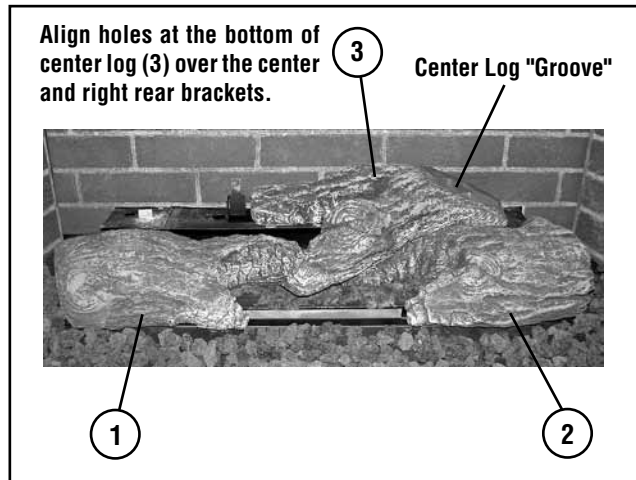

Step 3

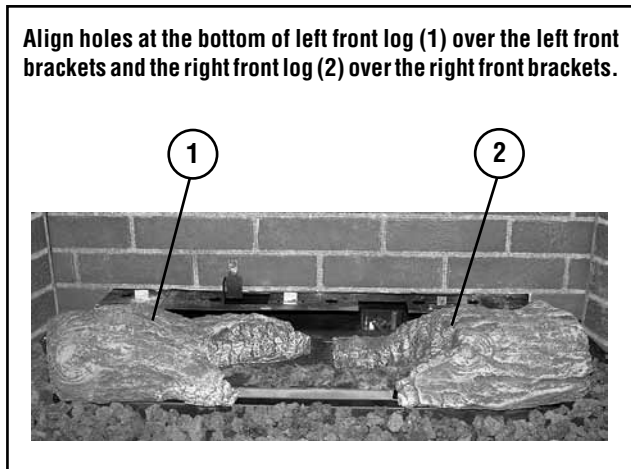

Step 2

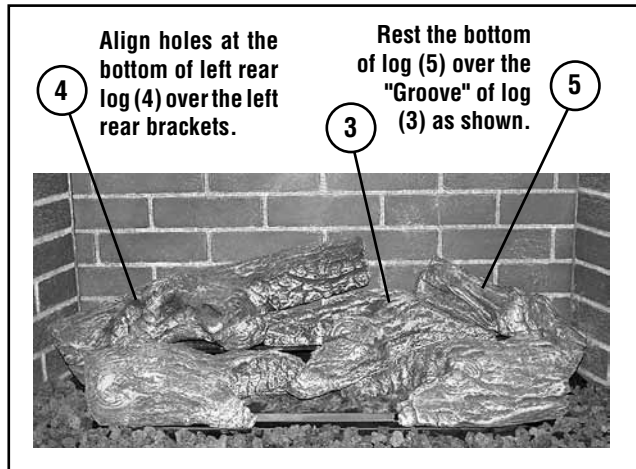

Step 4

Figure 11

**BURNER ADJUSTMENTS
(QUALIFIED TECHNICIANS ONLY)**

Flame Appearance and sooting

Proper flame appearance is a flame which is blue at the base and becomes yellowish-orange in the body of the flame. When the appliance is first lit, the entire flame may be blue and will gradually turn yellowish-orange during the first 15 minutes of operation. If after a short period the flame stays lowered blue, or if the flame is orange with evidence of sooting (black tip), the air shutter opening may need to be adjusted.

If the air shutter openings closed too far, sooting may develop. Sooting is indicated by black puffs developing at the tips of very long orange flames. Sooting results in black deposits forming on the logs, appliance inside surfaces and on exterior surfaces adjacent to the vent termination.

Sooting is caused by incomplete combustion in the flames and lack of combustion air entering the air shutter opening. To achieve a warm yellowish-orange flame with an orange body that does not soot, the shutter opening must be adjusted between these two extremes.

Air Shutter Adjustment Guidelines

- If there is smoke or soot present, first check the log set positioning to ensure that the flames are not impinging on any of the logs. If the log set is properly positioned and a sooting condition still exists, then the air shutter opening should be increased.
- The more offsets in the vent system, the larger the air shutter opening will need to be.
- An appliance operated with the air shutter opened too far, may have flames that appear blue and transparent. These weak, blue and transparent flames are termed anemic.
- Propane models may exhibit flames which candle or appear stringy. If this is present and persists, adjust the air shutter to a more open position, then operate the appliance for a few more minutes to ensure that the flame normalizes and the flames do not appear sooty.

The following chart is provided to aid you in achieving the correct air shutter adjustment for your installation.

Air Shutter Adjustment Guidelines:		
Amount of Primary Air	Flame Color	Air Shutter Adjustment
If air shutter is closed too far →	Flame will be orange →	Air shutter gap should be increased
If air shutter is open too far →	Flame will be blue →	Air shutter gap should be decreased



Figure 12 - Burner Flame Appearance Model SLDVT-30 and 35



Figure 13 - Burner Flame Appearance Model SLDVT-40



Figure 14 - Burner Flame Appearance Model SLDVT-45

Burner Air Shutter Adjustment Procedure

⚠ WARNINGS

- Air shutter adjustment should only be performed by a qualified professional service technician.
- Ensure front glass panel are in place and sealed during adjustment.

⚠ CAUTIONS

- Carbon will be produced if the air shutter is closed too much. Any damage due to carboning resulting from improperly setting the air shutter is not covered under the warranty.
- The air shutter door and nearby appliance surfaces are hot. Exercise caution to avoid injury while adjusting flame appearance.

1. Locate adjustment rod and adjust air shutter to the standard setting as shown in **Figure 15** (adjustment rod is located in the lower control compartment).

Note: Rotating the adjustment rod down to decrease air and up to increase air.

2. Light appliance (follow lighting procedure on lighting label in control compartment or see the lighting instructions, **Pages 22** and **24** in this manual).
3. Allow the burner to operate for at least 15 minutes while observing the flame continuously to ensure that the proper flame appearance has been achieved (see **Figures 12, 13 or 14**). If the following conditions are present, adjust accordingly.
 - If flame appears weak or sooty, adjust the air shutter, incrementally, to a more open position until the proper flame appearance is achieved.
 - If flame stays lowered blue, adjust the air shutter, incrementally, to a more closed position until the proper flame appearance is achieved.

4. Leave the control knob (off/pilot/on) in the ON position and the burner OFF/ON switch OFF (and remote switches, if applicable).
5. When satisfied that the burner flame appearance is normal, close the lower control compartment door (see **Figures 12, 13 and 14** on **Page 16**).

Burner Air Shutter Adjustment

Main Burner Factory Air Shutter Opening Setting - inches (millimeter)		
Model	Natural Gas	Propane Gas
SLDVT-30/35	Closed	3/32 (2.362)
SLDVT-40/45	Closed	3/32 (2.362)

Figure 15

Millivolt Appliance Checkout

The pilot flame should be steady, not lifting or floating. Flame should be blue in color with traces of orange at the outer edge.

The top 3/8" (10 mm) at the pilot generator (thermocouple) and the top 1/8" minimum (tip) of the quick drop out thermocouple should be engulfed in the pilot flame. The flame should project 1" (25 mm) beyond the hood at all three ports (see **Figure 16**).

To light the burner, refer to the lighting instructions on **Page 22**.

SIT MILLIVOLT PILOT ASSEMBLY

Proper Pilot Flame Appearance

Figure 16

Electronic Appliance Checkout

To light the burner, refer to the lighting instructions on **Page 24**. Ensure the igniter lights the pilot. The pilot flame should engulf the flame sensor as shown in **Figure 17**.

ELECTRONIC PILOT ASSEMBLY

Figure 17

ORDERING REPLACEMENT PARTS

A complete parts list is found at the end of this manual. Use only parts supplied from the manufacturer.

With proper care and maintenance, your appliance will provide many years of enjoyment. If you should experience any problem, first refer to the troubleshooting guide in this manual. If the problem persists, contact your Lennox Hearth Products dealer or distributor.

Order parts through your Lennox Hearth Products distributor or dealer. Parts will be shipped at prevailing prices at time of order.

When ordering parts, provide the following information:

1. Appliance model number.
2. Appliance serial number.
3. Part number.
4. Part description.
5. Quantity required.
6. Appliance installation date.

If you encounter any problems or have any questions concerning the installation or application of this system, please contact your dealer or distributor.

PRODUCT REFERENCE INFORMATION

We recommend that you record the important reference information about your fireplace in the space provided below.

Please call Lennox Hearth Products for the phone number of your nearest LHP dealer, who will answer your questions or address your concerns.

LENNOX HEARTH PRODUCTS
 1508 Elm Hill Pike, Suite 108
 Nashville, TN 37210
 Visit us at www.Lennox.com
 1-800-9-LENNOX

PRODUCT REFERENCE INFORMATION

Model Number _____
 Serial Number _____
 Date Installed _____
 Gas Type Used _____
 Dealer Name _____

WIRING DIAGRAMS

Wiring diagrams are provided here for reference purposes only. This information is also provided on schematics attached directly to the appliance on a pullout panel located within the control compartment.

CAUTION: LABEL ALL WIRES PRIOR TO DISCONNECTION WHEN SERVICING CONTROLS. WIRING ERRORS CAN CAUSE IMPROPER AND DANGEROUS APPLIANCE OPERATION.

ATTENTION: AU MOMENT DE L'ENTRETIEN DES COMMANDES, ÉTIQUÉTEZ TOUS LES FILS AVANT DE LES DÉBRANCHER. DES ERREURS DE CÂBLAGE PEU-VENT ENTRAÎNER UN FONCTIONNEMENT INADÉQUAT ET DANGEREUX.

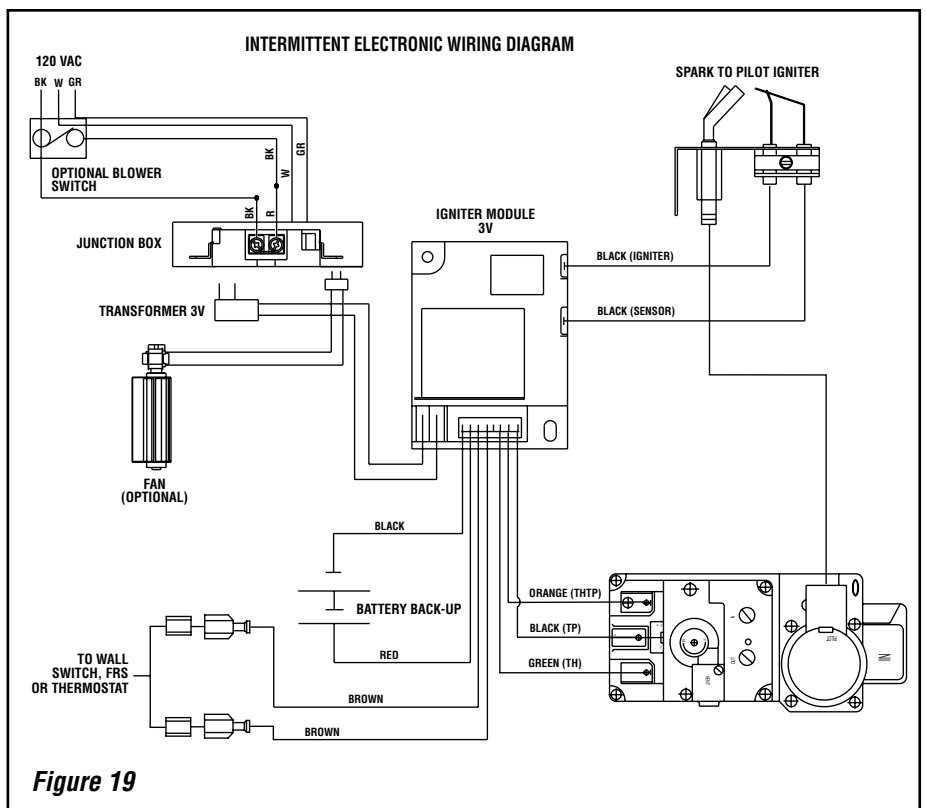
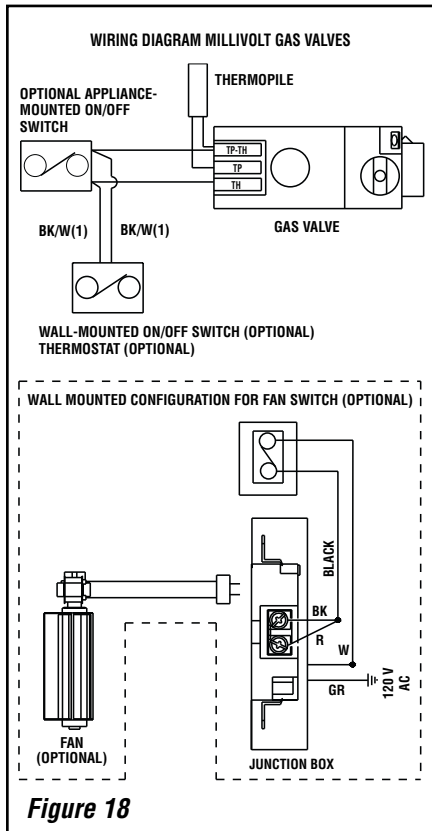

Unit Shipping Weights/Volumes			
Cat. No.	Model	Ship. Weight	Ship. Volume
H7496	SLDVT-30NM	78 lbs.	9.09 cu. ft.
H7497	SLDVT-30PM	78 lbs.	9.09 cu. ft.
H7498	SLDVT-30NE	78 lbs.	9.09 cu. ft.
H7282	SLDVT-35NM	86 lb.	10.61 cu. ft.
H7284	SLDVT-35PM	86 lb.	10.61 cu. ft.
H7286	SLDVT-35NE	86 lb.	10.61 cu. ft.
H7283	SLDVT-40NM	108 lb.	14.01 cu. ft.
H7285	SLDVT-40PM	108 lb.	14.01 cu. ft.
H7287	SLDVT-40NE	108 lb.	14.01 cu. ft.
H7499	SLDVT-45NM	122 lbs.	15.76 cu. ft.
H7500	SLDVT-45PM	122 lbs.	15.76 cu. ft.
H7501	SLDVT-45NE	122 lbs.	15.76 cu. ft.

ACCESSORY COMPONENTS



Digital Wall Thermostat

The wall thermostat kit provides temperature control for optimum comfort.

Wall Thermostat, Millivolt		
Cat. No.	Model No.	Description
H4635	DWTK	Wall Thermostat Kit, White

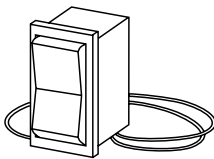

Unit-Mountable Rocker Switch

This rocker switch kit can be installed directly in the gas valve mounting bracket (millivolt gas valve equipped fireplaces) to provide On/Off operation in lieu of a wall switch.

Rocker Switch Kit		
Cat. No.	Model No.	Description
80L41	FRS	Rocker Switch Kit



Standard Remote Control System

The Model RCL (Standard) Remote Control System, features a simplistic OFF/ON control function for the fireplace. This model includes a hand-held transmitter, a remote receiver with wall-mount cover plate and all hardware required to install the unit. The remote receiver can be wall or hearth mounted.

The transmitter has ON and OFF functions that are activated by pressing either button on the face of the transmitter. When a button on the transmitter is pressed, a signal light illuminates briefly to verify that a signal has been sent.

The Model RCL is designed to operate with all millivolt ignition systems, as well as electronic ignition systems. It may be installed with use for either natural gas or propane gas appliances. The RCL offers ease of installation and allows you to execute on-off commands to the fireplace effortlessly with one simple motion.

The Model RCL comes complete with detailed operating instructions.

Remote Control Kit, Standard		
Cat. No.	Model No.	Description
H0249	RCL	Remote Control System (Standard)

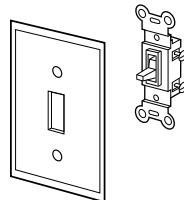

OFF/ON Wall Switch Kit

The OFF/ON wall switch kit may be used to control the operation of the fireplace burner or blower. Install the OFF/ON wall switch in a convenient location near the fireplace.

White Wall Switch Kit		
Cat. No.	Model No.	Description
85L87	FWSK	OFF/ON Wall Switch Kit



Deluxe Remote Control System

The Model RCL-T (Deluxe) Remote Control System has all of the features of the standard system along with an added easy to read LCD screen which presents access to many enhancements, including; battery power level indicator, timer, mode of operation, thermostatic display including room temperature in either metric or English units, flame indicator and clock. Fully programmable, the Model RCL-T allows for virtual command over nearly all operational and temperature variables, using the hand held remote control transmitter.

The Model RCL-T (Deluxe) remote control system is installed in the same manner as the standard system, may be operated with electronic and millivolt systems with either natural gas or propane gas. The RCL-T comes complete with detailed operating instructions.

Remote Control Kit, Deluxe		
Cat. No.	Model No.	Description
H0251	RCL-STAT	Remote Control System (Deluxe)

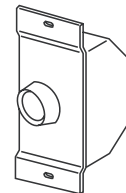

Variable Speed Wall Switch

Provides variable speed control if optional blower kit is purchased.

Variable Speed Wall Switch		
Cat. No.	Model No.	Description
045571H	VSWS	Rocker Switch Kit

ACCESSORY COMPONENTS (continued)

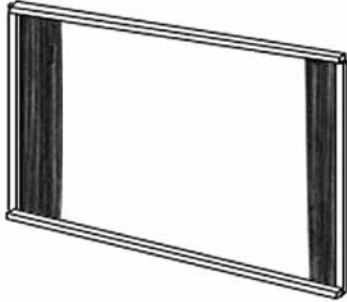

Pull Screen Panel Kit

This easy to install optional decorative screen kit installs over the standard glass enclosure panel. These screen kits cannot be used in conjunction with the arch door kits or door frame kits.

Screen Panel Kits		
Cat. No.	Model No.	Models Where Used
H6112	PSFPKM30	SLDVT-30
H6113	PSFPKM35	SLDVT-35
H6114	PSFPKM40	SLDVT-40
H6115	PSFPKM45	SLDVT-45

Style View Screen Doors -

These Style View doors are easy to install and will not require hardware to attach them to the standard glass door frame. The Style View door installs over the standard glass enclosure panel and provides a barrier to prevent direct contact with the hot glass surface. The door includes heavy duty magnet door latches and functional twin-pane screen doors.

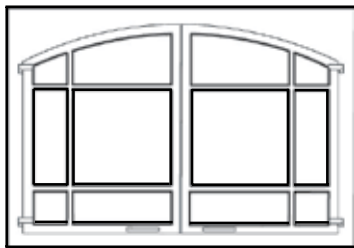

Arch Pane Design

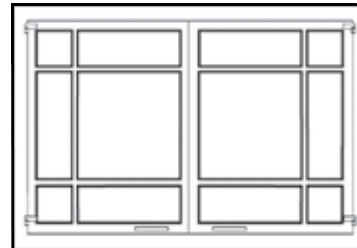

Square Pane Design

ARCH PANE DESIGN KITS			
Cat. No.	Model	Description	Model Series
H6104	APDML30C	30" Arch Pane Door, Painted	SLDVT-30
H6105	APDML30SP	30" Arch Pane Door, Satin Pewter	
H6106	APDML35C	35" Arch Pane Door, Painted	SLDVT-35
H6107	APDML35SP	35" Arch Pane Door, Satin Pewter	
H6108	APDML40C	40" Arch Pane Door, Painted	SLDVT-40
H6109	APDML40SP	40" Arch Pane Door, Satin Pewter	
H6110	APDML45C	45" Arch Pane Door, Painted	SLDVT-45
H6111	APDML45SP	45" Arch Pane Door, Satin Pewter	

SQUARE PANE DESIGN KITS			
Cat. No.	Model	Description	Model Series
H6096	SPDML40C	30" Square Pane Door, Painted	SLDVT-30
H6097	SPDML40SP	30" Square Pane Door, Satin Pewter	
H6098	SPDML35C	35" Square Pane Door, Painted	SLDVT-35
H6099	SPDML35SP	35" Square Pane Door, Satin Pewter	
H6100	SPDML40C	40" Square Pane Door, Painted	SLDVT-40
H6101	SPDML40SP	40" Square Pane Door, Satin Pewter	
H6102	SPDML45C	45" Square Pane Door, Painted	SLDVT-45
H6103	SPDML45SP	45" Square Pane Door, Satin Pewter	

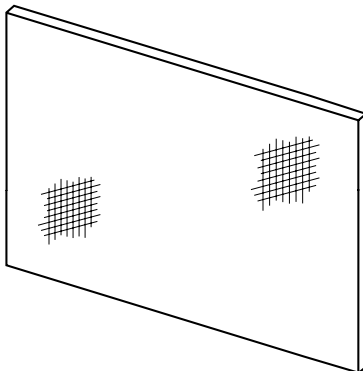

Barrier Screen Panel Kit

This easy to install optional screen panel installs over the standard glass enclosure panel and provides a barrier to prevent direct contact with the hot glass surface. These screen panels cannot be used in conjunction with the arch door kits or door frame kits.

Barrier Screen Panel Kits		
Cat. No.	Model No.	Models Where Used
H6094	30MSKP	SLDVT-30
H6095	35MSPK	SLDVT-35
H3989	40LSPK	SLDVT-40
H3990	45LSPK	SLDVT-45

ACCESSORY COMPONENTS (continued)

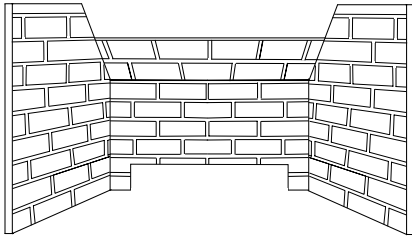

Brickaded Panel Liner Kit

The brickaded liner kits include ceramic panels as shown here. The panels have brick-like features in relief.

Brickaded Wall Liner Kits		
Cat. No.	Model No.	Description
H7502	BLPK-30TB	Brick Liner Kit, Buff SLDVT-30
H7288	BLPK-35TB	Brick Liner Kit, Buff SLDVT-35
H7289	BLPK-40TB	Brick Liner Kit, Buff SLDVT-40
H7503	BLPK-45TB	Brick Liner Kit, Buff SLDVT-45
H7505	BLPK-30TR	Brick Liner Kit, Red SLDVT-30
H7290	BLPK-35TR	Brick Liner Kit, Red SLDVT-35
H7291	BLPK-40TR	Brick Liner Kit, Red SLDVT-40
H7505	BLPK-45TR	Brick Liner Kit, Red SLDVT-45



Touch-Up Paint Kit

Repair of minor scratches and discoloration of the appliance black painted surfaces may be accomplished with the touch-up paint kit.

Touch-Up Paint Kits (all models)		
Cat. No.	Model No.	Description
90L73	FTPK-B	Touch-Up Paint (Black)

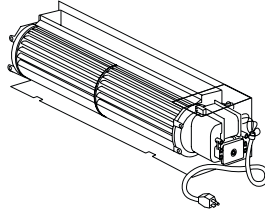

Forced Air Kit

The FBK-100 blower provides constant velocity forced air circulation. The FBK-200 assembly with variable speed, wall-mountable switch provides variable speed forced air circulation. The FBK-300 features and automatic thermo-sensitive control.

Forced Air Blower Kits		
Cat. No.	Model No.	Description
80L84	FBK-100	Blower, Standard (single speed)
80L85	FBK-200	Blower, Variable Speed (w/wall-mounted switch)
H7841	FBK-300	Blower, Variable Speed (w/thermal snap switch)

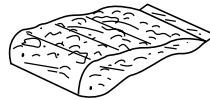

**Bag of Glowing Embers
Bag of Volcanic Stone**

Replacement ember materials or volcanic stone are available for use with these appliances. Order kits as part of the periodic maintenance of the appliance.

Decorative Firebox Accessories (all models)		
Cat. No.	Model No.	Description
88L53	FGE	Bag of Glowing Embers
80L42	FDVS	Bag of Decorative Volcanic Stone

Termination Shroud (Fits H1968)

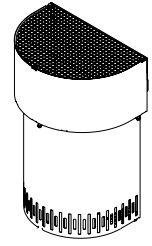

Deluxe Termination Guard (Fits 94L10)

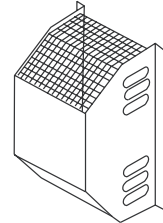

Square Termination Guard (Fits 94L10)

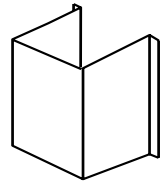

Termination Guard Kits

The vent termination guards may be used to cover the vent termination on the exterior of the home to minimize exposure to the hot surface of the termination.

Termination Guard Kits (all models)		
Cat. No.	Model No.	Description
H5820	4.5HTSK	Termination Shroud
87L02	SV4.5HGS	Termination Guard, Deluxe
17M52	SV4.5HGS-1	Termination Guard, Square

LIGHTING INSTRUCTIONS – MILLIVOLT GAS VALVE

FOR YOUR SAFETY, READ BEFORE LIGHTING

WARNING: If you do not follow these instructions exactly, a fire or explosion may result, causing property damage, personal injury, or loss of life.

A. This appliance has a pilot that must be lighted by a piezo igniter. When lighting the pilot, follow these instructions exactly.

B. **BEFORE LIGHTING**, smell all around the appliance area for gas. Be sure to smell next to the floor because some gas is heavier than air and will settle on the floor.

WHAT TO DO IF YOU SMELL GAS:

- Do not try to light any appliance.
- Do not touch any electric switch; do not use any phone in your building.



- Immediately call your gas supplier from a neighbor's phone. Follow the gas supplier's instructions.

- If you cannot reach your gas supplier, call the fire department.

C. Use only your hand to push in or turn the gas control knob. Never use tools. If the knob will not push in or turn by hand, don't try to repair it; call a qualified service technician. Forced or attempted repair may result in a fire or explosion.

D. Do not use this appliance if any part has been under water. Immediately call a qualified service technician to inspect the appliance and to replace any part of the control system and any gas control that has been under water.

LIGHTING INSTRUCTIONS

1. STOP! Read the safety information above on this label.
2. (If applicable) Set the thermostat to lowest setting. Turn wall on/off switch, unit mounted on/off switch or remote control switch "OFF."
3. Turn OFF all electric power to the appliance.
4. Access the control compartment.
5. Push in gas control knob slightly and turn clockwise  to "OFF."
NOTE: Knob cannot be turned from "PILOT" to "OFF" unless knob is pushed in slightly. Do Not force.
6. Wait five (5) minutes to clear out any gas. Then smell for gas, including near the floor. If you smell gas, STOP! Follow "B" in the safety information above on this label. If you don't smell gas, go to the next step.
7. Find pilot — located in firebox on the same plane as the top of the burner.
8. Turn knob on gas control counterclockwise  to "PILOT."
9. Push in control knob all the way and hold in. Immediately light the pilot by triggering the piezo igniter (pushing the button) until pilot lights. Continue to hold the control knob in for about 1-1/2 minutes after the pilot is lit. Release knob and it will pop back up. Pilot should remain lit. If it goes out, repeat steps 5 through 9.
 - If knob does not pop up when released, stop and immediately call your service technician or gas supplier.

- If the pilot will not stay lit after several tries, turn the gas control knob to "OFF," and call your service technician or gas supplier.
10. Turn gas control knob counterclockwise  to "ON."
 11. Close control compartment.
 12. (If applicable) Turn on all electrical power to the appliance.
 13. (If applicable) Set thermostat to desired setting. Turn wall on/off switch, unit mounted on/off switch or remote control switch "ON."

Gas Control Valves

Pilot Assemblies

SIT

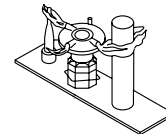
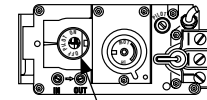

Gas Control Knobs

Robertshaw

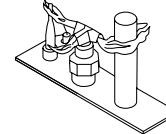
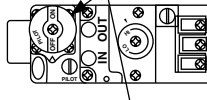

Honeywell

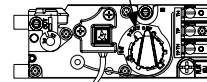

TO TURN OFF GAS TO APPLIANCE

1. (If applicable) Set the thermostat to lowest setting. Turn wall on/off switch, unit mounted on/off switch or remote control switch "OFF."
2. Turn OFF all electric power to the appliance if service is to be performed.
3. Access the control compartment.
4. Push in gas control knob slightly and turn clockwise  to "OFF." Do not force.
5. Close the main line gas shut-off valve.
6. Close control compartment.



WARNING



**HOT GLASS WILL CAUSE BURNS.
DO NOT TOUCH GLASS UNTIL COOLED.
NEVER ALLOW CHILDREN TO TOUCH GLASS.**

INSTRUCTIONS D'ALLUMAGE – VANNE GAZ MILLIVOLT

POUR PLUS DE SÉCURITÉ, LIRE AVANT D'ALLUMER

AVERTISSEMENT. Quiconque ne respecte pas à la lettre les instructions dans la présente notice risque de déclencher un incendie ou une explosion entraînant des dommages, des blessures ou la mort.

A. Cet appareil est muni d'une veilleuse qui doit être allumée avec un allumeur piézo-électrique. Respectez les instructions ci-dessous à la lettre.

B. **AVANT L'ALLUMAGE:** Avant d'allumer la veilleuse, reniflez tout autour de l'appareil pour déceler une odeur de gaz. Reniflez près du plancher, car certains gaz sont plus lourds que l'air et peuvent s'accumuler au niveau du sol.

QUE FAIRE SI VOUS SENTEZ UNE ODEUR DE GAZ :

- Ne pas tenter d'allumer d'appareil.
- Ne touchez à aucun interrupteur ; ne pas vous servir des téléphones se trouvant dans le bâtiment.

- Appelez immédiatement votre fournisseur de gaz depuis un voisin. Suivez les instructions du fournisseur.
- Si vous ne pouvez rejoindre le fournisseur, appelez le service des incendies.

C. Ne pousser ou tourner la manette d'admission du gaz qu'à la main. Ne jamais employer d'outil à cette fin. Si la manette reste coincée, ne tentez pas de la réparer; appelez un technicien qualifié. Quiconque tente de forcer la manette ou de la réparer peut provoquer une explosion ou un incendie.

D. N'utilisez pas cet appareil s'il a été plongé dans l'eau, même partiellement. Faites inspecter l'appareil par un technicien qualifié et remplacez toute partie du système de contrôle et toute commande qui ont été plongés dans l'eau.

INSTRUCTIONS D'ALLUMAGE

1. **ARRÊTEZ !** Lisez les instructions de sécurité sur la portion supérieure de cette étiquette.
2. (Si applicable) Réglez le thermostat à la température la plus basse. Tournez l'interrupteur murale, l'interrupteur sur l'unité ou le contrôle à distance à "OFF."
3. Coupez l'alimentation électrique de l'appareil.
4. Accédez au compartiment de contrôle.
5. Enfoncez légèrement le bouton de réglage du gaz et tournez-le dans le sens des aiguilles d'une montre jusqu'à la position d'arrêt "OFF".
Remarque: Il est impossible de tourner le bouton de "PILOT" à "OFF" à moins qu'il ne soit légèrement enfoncé. Ne le forcez pas.
6. Attendez cinq (5) minutes pour laisser échapper tout le gaz. Reniflez tout autour de l'appareil, y compris près du plancher, pour déceler une odeur de gaz. Si vous sentez une odeur de gaz, **ARRÊTEZ !** Passez à l'étape B des instructions de sécurité sur la portion supérieure de cette étiquette. S'il n'y a pas d'odeur de gaz, passez à l'étape suivante.
7. Trouver le pilote – Situé dans l'âtre sur la même surface que le dessus du brûleur.
8. Tournez le bouton de contrôle sur la valve à gaz dans le sens antihoraire vers "Pilote".
9. Enfoncez le bouton de réglage jusqu'au fond et gardez-le enfoncé. Allumez immédiatement la veilleuse en déclenchant l'allume-gaz à étincelle (en poussant le bouton) jusqu'à ce que la veilleuse s'enflamme. Continuez de tenir le bouton de réglage enfoncé pendant environ 90 secondes après l'allumage de la veilleuse. Relâchez le bouton et il sortira subitement. La veilleuse devrait rester allumée. Si elle s'éteint, répétez les étapes 5 à 8 inclusivement.

- Si la manette ne se soulève pas d'elle-même lorsqu'on la relâche, arrêter et appeler immédiatement un technicien qualifié ou le fournisseur de gaz.
 - Si la veilleuse ne reste pas allumée après plusieurs tentatives, réglez la manette d'admission du gaz à la position OFF et appelez un technicien qualifié ou le fournisseur de gaz.
10. Tournez le bouton de réglage du gaz en sens inverse des aiguilles d'une montre jusqu'à sa position de marche "ON".
 11. Fermer le compartiment de contrôle.
 12. (Si applicable) Mettez l'appareil sous tension.
 13. (Si applicable) Réglez le thermostat à la température désirée. Tournez l'interrupteur murale, l'interrupteur sur l'unité ou le contrôle à distance à "ON."

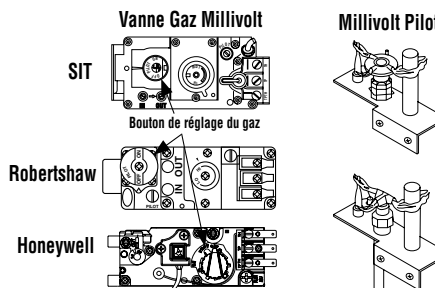

COMMENT COUPER L'ADMISSION DE GAZ DE L'APPAREIL

1. (Si applicable) Réglez le thermostat à la température la plus basse. Tournez l'interrupteur murale, l'interrupteur sur l'unité ou le contrôle à distance à "OFF."
2. Coupez l'alimentation électrique de l'appareil s'il faut procéder à l'entretien.
3. Accédez au compartiment de contrôle.
4. Enfoncez légèrement le bouton de réglage du gaz et tournez-le dans le sens des aiguilles d'une montre jusqu'à la position d'arrêt "OFF". Ne forcez pas le bouton.
5. Fermer la valve de gaz principale.
6. Fermer le compartiment de contrôle.



AVERTISSEMENT



UNE SURFACE VITRÉE CHAUDE PEUT CAUSER DES BRÛLURES.
LAISSER REFROIDIR LA SURFACE VITRÉE AVANT D'Y TOUCHER.
NE PERMETTEZ JAMAIS À UN ENFANT DE TOUCHER LA SURFACE VITRÉE.

LIGHTING INSTRUCTIONS — ELECTRONIC

FOR YOUR SAFETY, READ BEFORE OPERATING

WARNING: If you do not follow these instructions exactly, a fire or explosion may result, causing property damage, personal injury or loss of life.

A. This appliance is equipped with an ignition device which automatically lights the pilot. Do not try to light the pilot by hand.

B. BEFORE OPERATING smell all around the appliance area for gas. Be sure to smell next to the floor because some gas is heavier than air and will settle on the floor.

WHAT TO DO IF YOU SMELL GAS:

- Do not try to light any appliance.
- Do not touch any electric switch; do not use any phone in your building.

- Immediately call your gas supplier from a neighbor's phone. Follow the gas supplier's instructions.
- If you cannot reach your gas supplier, call the fire department.

C. If any portion of this appliance does not operate as the instructions indicate, do not try to repair it, call a qualified service technician. Do not use tools. Force or attempted repair may result in a fire or explosion.

D. Do not use this appliance if any part has been under water. Immediately call a qualified service technician to inspect the appliance and to replace any part of the control system and any gas control which has been under water.

OPERATING INSTRUCTIONS

1. STOP! Read the safety information above on this label.
2. (If applicable) Set the thermostat to lowest setting. Turn wall on/off switch, unit mounted on/off switch or remote control switch "OFF." If used, remove the batteries from the battery holder.
3. Turn OFF all electric power to the appliance.
4. This appliance is equipped with an ignition device which automatically lights the pilot. Do not try to light the pilot by hand.
5. Access the control compartment.
6. Wait five (5) minutes to clear out any gas. If you smell gas, STOP! Follow "B" in the safety information above on this label. If you don't smell gas, go to the next step.
7. Turn on all electrical power to the appliance.
8. (If applicable) Set thermostat to desired setting. Turn wall on/off switch, unit mounted on/off switch or remote control switch "ON." Replace the batteries in the battery holder, if used.

9. Close control compartment.
10. If the appliance will not operate, follow the instructions under "To Turn Off Gas To Appliance," and call your service technician or gas supplier.

Electronic Gas Control Valve - DEXEN

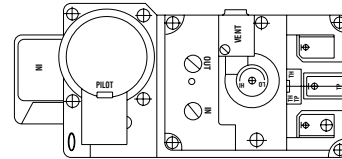

Electronic Pilot Assembly



TO TURN OFF GAS TO APPLIANCE

1. (If applicable) Set the thermostat to lowest setting. Turn wall on/off switch, unit mounted on/off switch or remote control switch "OFF."
2. Turn OFF all electric power to the appliance and remove

- backup batteries, if service is to be performed.
3. Access the control compartment.
4. Close the main line gas shut-off valve.
5. Close control compartment.



WARNING



**HOT GLASS WILL CAUSE BURNS.
DO NOT TOUCH GLASS UNTIL COOLED.
NEVER ALLOW CHILDREN TO TOUCH GLASS.**

INSTRUCTIONS D'ALLUMAGE — ELECTRONIC

POUR PLUS DE SÉCURITÉ LIRE AVANT DE METTRE EN MARCHÉ

AVERTISSEMENT. Quiconque ne respecte pas à la lettre les instructions dans la présente notice risque de déclencher un incendie ou une explosion entraînant des dommages, des blessures ou la mort.

- A. Cet appareil est muni d'un dispositif d'allumage qui allume automatiquement la veilleuse. Ne tentez pas d'allumer la veilleuse manuellement.
- B. **AVANT DE FAIRE FONCTIONNER**, reniflez tout autour de l'appareil pour déceler une odeur de gaz. Reniflez près du plancher, car certains gaz sont plus lourds que l'air et peuvent s'accumuler au niveau du sol.

QUE FAIRE SI VOUS SENTEZ UNE ODEUR DE GAZ :

- Ne pas tenter d'allumer d'appareil.
- Ne touchez à aucun interrupteur; ne pas vous servir des téléphones se trouvant dans le bâtiment.

- Appelez immédiatement votre fournisseur de gaz depuis un voisin. Suivez les instructions du fournisseur.
 - Si vous ne pouvez rejoindre le fournisseur, appelez le service des incendies.
- C. Si un élément de cette unité ne fonctionne pas tel que décrit dans les instructions, n'essayez pas de le réparer, appelez un technicien qualifié. N'utilisez pas d'outils. Le fait de forcer la manette ou de la réparer peut déclencher une explosion ou un incendie.
- D. N'utilisez pas cet appareil s'il a été plongé dans l'eau, même partiellement. Faites inspecter l'appareil par un technicien qualifié et remplacez toute partie du système de contrôle et toute commande qui ont été plongés dans l'eau.

INSTRUCTIONS DE MISE EN MARCHÉ

1. **ARRÊTEZ !** Lisez les instructions de sécurité sur la portion supérieure de cette étiquette.
2. (Si applicable) Réglez le thermostat à la température la plus basse. Tournez l'interrupteur murale, l'interrupteur sur l'unité ou le contrôle à distance à "OFF." Si l'appareil fonctionne avec des batteries, retirez-les de leur support.
3. Coupez l'alimentation électrique de l'appareil.
4. Cet appareil est muni d'un dispositif d'allumage qui allume automatiquement la veilleuse. Ne tentez pas d'allumer la veilleuse manuellement.
5. Accédez au compartiment de contrôle.
6. Attendre cinq (5) minutes pour laisser échapper tout le gaz. Reniflez tout autour de l'appareil, y compris près du plancher, pour déceler une odeur de gaz. Si vous sentez une odeur de gaz, **ARRÊTEZ !** Passez à l'étape B des instructions de sécurité sur la portion supérieure de cette étiquette. S'il n'y a pas d'odeur de gaz, passez à l'étape suivante.
7. Mettez l'appareil sous tension.
8. (Si applicable) Réglez le thermostat à la température désirée. Tournez l'interrupteur murale, l'interrupteur sur l'unité ou le contrôle à distance à "ON." Remplacer les batteries dans leur support.
9. Fermer le compartiment de contrôle.
10. Si l'appareil ne se met pas en marche, suivez les instructions intitulées « Comment couper l'admission de gaz de l'appareil » et appelez un technicien qualifié ou le fournisseur de gaz.

Valve électronique - DEXEN

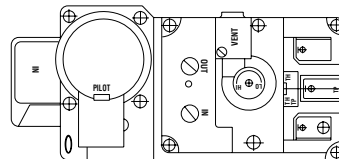

Veilleuse de l'appareil électronique



COMMENT COUPER L'ADMISSION DE GAZ DE L'APPAREIL

1. (Si applicable) Réglez le thermostat à la température la plus basse. Tournez l'interrupteur murale, l'interrupteur sur l'unité ou le contrôle à distance à "OFF."
2. Couper toute alimentation électrique et retirer les batteries de leur support, si un entretien doit être fait sur l'unité.
3. Accédez au compartiment de contrôle.
4. Fermer la valve de gaz principale.
5. Fermer le compartiment de contrôle.



AVERTISSEMENT



**UNE SURFACE VITRÉE CHAUDE PEUT CAUSER DES BRÛLURES.
LAISSER REFROIDIR LA SURFACE VITRÉE AVANT D'Y TOUCHER.
NE PERMETTEZ JAMAIS À UN ENFANT DE TOUCHER LA SURFACE VITRÉE.**

MAINTENANCE SCHEDULE

Annually (Before the onset of the Burning Season)

MAINTENANCE TASK	ACCOMPLISHING PERSON	PROCEDURE
Inspecting/Cleaning Burner, Logs and Controls	Qualified Service Technician	Inspect valve and ensure it is properly operating. Check piping for leaks. Vacuum the control compartment, fireplace logs and burner area.
Check Flame Patterns and Flame Height	Qualified Service Technician	Refer to Figures 12 through 14 on Page 16 and verify the flame pattern and height displayed by the appliance conforms to the picture. Flames must not impinge on the logs. Ensure flames are steady (not lifting or floating).
Inspecting/Cleaning Pilot and Burner	Qualified Service Technician	Refer to Figure 16 (SIT Millivolt) or Figure 17 (Electronic) on Page 17 . Remove any surface build-up on pilot and burner assembly. Wipe the pilot nozzles, igniter/flame rod and hood. Ensure the pilot flame engulfs the flame sensor as shown.
Checking Vent System	Qualified Service Technician	Inspect the vent system at the top and at the base (within the firebox) for signs of blockage or obstruction. Look for any signs of dislocation or deterioration of the vent components. Note: Excessive condensation can cause corrosion of caps, pipe and fittings (excessive condensation can be caused by long lateral runs, too many elbows and/or exterior portions of the system being exposed to cold weather). Also inspect wall straps or plumbers's tape to ensure it is secure and in place.
Appliance Checkout	Qualified Service Technician	Perform the appropriate appliance checkout procedure detailed in this manual.
Replacing Rockwool Ember Materials	Homeowner/Qualified Service Technician	Remove old ember materials (rockwool) and vacuum the ember placement area. Place new embers as described and shown in Figures 9 and 10 .

Periodically (After the Burning Season)

MAINTENANCE TASK	ACCOMPLISHING PERSON	PROCEDURE
Cleaning Firebox Interior	Homeowner	Carefully remove logs, rockwool and volcanic stone. Vacuum out interior of the firebox. Clean firebox walls and log grate. Replace logs, rockwool, and volcanic stone as detailed in this manual.
Check Flame Patterns and Flame Height	Homeowner	Refer to Figures 12 through 14 on Page 16 and verify the flame pattern and height displayed by the appliance conforms to the picture. Flames must not impinge on the logs.
Checking Vent System	Homeowner	Inspect the vent system at the top and at the base (within the firebox) for signs of blockage or obstruction. Look for any signs of dislocation of the vent components.
Cleaning Front Glass Enclosure Panel	Homeowner	Clean as necessary following the directions provided in this manual. DO NOT TOUCH OR ATTEMPT TO CLEAN GLASS WHILE HOT.

TROUBLESHOOTING THE MILLIVOLT CONTROL SYSTEM

Note: Before troubleshooting the gas control system, Ensure external gas shut off valve, located at gas supply inlet, (and wall switch, iff applicable), is in the “ON” position.

Important: Valve system troubleshooting should only be accomplished by a qualified service technician.

SYMPTOM	POSSIBLE CAUSES	CORRECTIVE ACTION
<p>1. Spark igniter will not light pilot after repeated triggering of igniter button.</p> <p>WARNING: if the pilot will not light after 1 minute of attempting, wait for at least 5 minutes for gas to clear before attempting again.</p>	<p>A. Defective igniter (no spark at electrode).</p>	Check for spark at electrode and pilot; if no spark and electrode wire is properly connected, replace igniter.
	<p>B. Defective or misaligned electrode at pilot (spark at electrode).</p>	Using a match, light pilot. If pilot lights, turn off pilot and trigger the igniter button again. If pilot lights, an improper gas mixture caused the bad lighting and a longer purge period is recommended. If pilot will not light – check gap at electrode and pilot – should be 1/8" to have a strong spark. If gap measures 1/8", replace pilot (see Figure 16 on Page 17).
	<p>C. Gas supply pressure errant.</p>	Check inlet gas pressure. It should be within the limits as marked on the rating plate.
	<p>D. Pilot orifice plugged.</p>	Clean or replace pilot orifice.
<p>2. Pilot will not stay lit after carefully following the lighting instructions.</p>	<p>A. Defective pilot generator (thermocouple).</p>	Check pilot flame, it must impinge on thermocouple (see Figure 16 on Page 17). Clean and/or adjust pilot for maximum flame impingement on thermocouple. Ensure that the connection between the valve and thermocouple are tight and secure.
<p>3. Pilot burning, no gas to burner, Valve knob “ON,” and the (standard) burner OFF/ON switch is “ON.” Read important note below.</p> <p>IMPORTANT NOTE: If an optional *remote switch is used for burner operation, if the standard burner OFF/ON switch is still installed on appliance it must be in the “OFF” position.</p> <p>* Optional remote switch kits - wall switch, wall thermostat or remote control.</p>	<p>A. Wall switch or wires defective.</p>	Check wall switch and wires for proper connections. Jumper wire across terminals at wall switch, if burner comes on, replace defective wall switch. If okay, jumper wires across wall switch wires at valve, if burner comes on, wires are faulty or connections are bad.
	<p>B. Thermopile may not be generating sufficient millivolts.</p>	Check thermopile with millivolt meter. Take reading at thermopile terminals of gas valve. Should read 325 millivolts minimum with optional wall switch “OFF.” Replace faulty thermopile if reading is below specified minimum.
	<p>C. Plugged burner orifice.</p>	Check burner orifice for blockage and remove.
	<p>D. OFF/ON Switch and *Remote Switch are in the “ON” position resulting in excessive resistance.</p>	When turning on the burner using a *remote switch, ensure that the standard OFF/ON switch is in the “OFF” position. If both switches are in the ON position, it may result in excessive resistance (and millivolt drainage) and the burner may not come on.
<p>4. Frequent pilot/burner outage problem.</p>	<p>A. Pilot flame may be too low or blowing (high) causing the pilot/valve safety to drop out.</p>	Clean and/or adjust pilot flame for maximum flame impingement on thermocouple (see Figure 16 on Page 17).

TROUBLESHOOTING THE ELECTRONIC IGNITION SYSTEM

Note: Before troubleshooting, be sure that the appliance main line gas shut-off valve, the gas control valve and the wall switch are in the "ON" position.

Important: Valve system troubleshooting should only be accomplished by a qualified service technician.

SYMPTOM	POSSIBLE CAUSES	CORRECTIVE ACTION
1. Nothing happens when ON/OFF switch is turned on (pilot does not spark).	A. Low voltage/or bad lead wires.	Check voltage on AC terminals of module an/or batteries. The value should be around 2.7 to 3.2 VAC. Confirm that wire connections are secure.
	B. Damaged igniter wire.	Check for visible cracked casing, cuts, etc.
	C. Damaged pilot assembly.	Check pilot assembly for visibly broken spark electrode, etc.
	D. Batteries Low	Check voltage on D.C. terminal of batteries. The value should be around 3.0V
2. The main burner does not light and the igniter is sparking.	A. No fuel supply.	Ensure that the gas supply is turned on.
	B. Loose sensor wire.	Ensure sensor wire connection is secure.
	C. Lose wires to valve.	Ensure black, green and orange wires connection is secure to valve.
	D. Loose wires to ignition module.	Ensure black sensor wire (S) and black igniter wire (I) is secure to ignition module.
	E. Air in the gas line.	Purge gas line of air.
	F. Low voltage.	Test voltage at AC terminals of module and/or batteries. It should be around 2.7 to 3.2 VAC.
3. The main burner come "ON" but then go "OFF".	A. Gas supply is turned "OFF".	Turned gas supply to "ON".
	B. Loose wire connection on valve or ignition module.	Check wire connection.
	C. Flame does not engulf flame sensor.	Check location of sensor.
	D. Obstructed vent system.	Check vent system for obstructions.
4. The log and glass soot.	A. Flame impingement on the log.	Check for proper log placement.
	B. Improper air shutter opening.	Check for proper air shutter openings.

REPLACEMENT PARTS LIST

Item No.	Description	SLDVT-30		SLDVT-35		SLDVT-40		SLDVT-45	
		Part No.	Qty.	Part No.	Qty.	Part No.	Qty.	Part No.	Qty.
1	Hood	H7568	1	H7266	1	H7267	1	H7569	1
2	Lower Control Compartment Panel	H7556	1	H7262	1	H7263	1	H7557	1
3	Enclosure, Glass Front (Complete)	H7560	1	H7264	1	H7265	1	H7561	1
4	Door Latch Spring	H1264	2	H1264	2	H1264	2	H1264	2
5	Log Set (Complete)	H7244	1	H7244	1	H7245	1	H7547	1
6	Burner Assembly	H7258	1	H7253	1	H7259	1	H7550	1
7	Orifice, Main Burner - Natural Gas	H4873	1	H1355	1	60J80	1	37L70	1
7	Orifice, Main Burner - Propane Gas	35M91	1	75L10	1	99K78	1	99K79	1
8	Bag of Glowing Embers (Rockwool)	88L53	1	88L53	1	88L53	1	88L53	1
8	Bag of Decorative Volcanic Stone	80L42	1	80L42	1	80L42	1	80L42	1
9	Orifice Holder	H7257	1	H7257	1	H7257	1	H7257	1
10	Gas Line Flexible Connector	93L32	1	93L32	1	93L32	1	93L32	1
11	Sub-Floor	H7558	1	H7450	1	H7462	1	H7741	1

Gas Controls - SIT Millivolt

Item No.	Description	Natural Gas		Propane Gas	
		Part No.	Qty.	Part No.	Qty.
15	Gas Valve, SIT	H6209	1	88J53	1
16	Piezo Igniter	10K86	1	10K86	1
---	Piezo Igniter Wire	56L21	1	56L21	1
17	Pilot Assembly	69L17	1	69L18	1
18	Pilot Generator	60J79	1	60J79	1
19	Thermocouple	74L57	1	74L57	1
20	Pilot Tube	74L56	1	74L56	1
21	Electrode and Cable	74L58	1	74L58	1

Gas Controls - Dexen Electronic

Item No.	Description	Natural Gas	
		Part No.	Qty.
28	Gas Valve, Dexen	H4681	1
29	Pilot Assembly	H4673	1
30	Igniter Module	H4674	1
31	Battery Holder	H4675	1
32	Wire Harness	H4676	1
33	Adaptor	H4677	1

Contact an Authorized Lennox Hearth Products dealer to obtain any of these parts. Never use substitute materials. Use of non-approved parts can result in poor performance and safety hazards.

 **WARNING**

Failure to position the parts in accordance with these diagrams or failure to use only parts specifically approved with this appliance may result in property damage or personal injury.

 **AVERTISSEMENT**

Risque de dommages ou de blessures si les pièces ne sont pas installées conformément à ces schémas et ou si des pièces autres que celles spécifiquement approuvées avec cet appareil sont utilisées.

REPLACEMENT PARTS

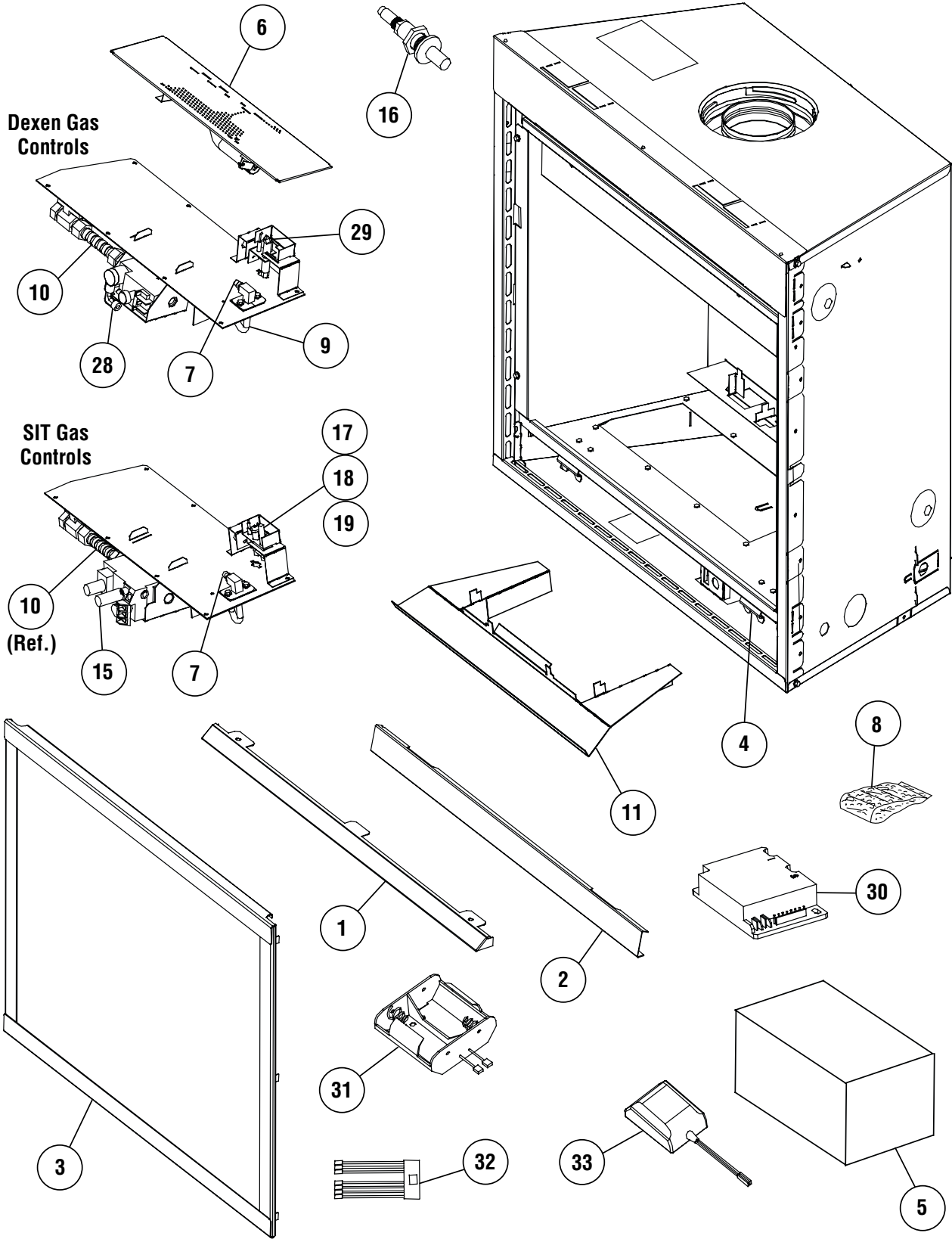

Notes

Lennox Hearth Products reserves the right to make changes at any time, without notice, in design, materials, specifications, and prices, and also to discontinue colors, styles, and products. Consult your local distributor for fireplace code information.