

TECHNICAL SPECIFICATIONS		
VOLTS		120
AMPS		12.5
WATTS		1500
HEATER	HIGH	1500 watts
	LOW	750 watts
NO HEATER		22 watts
LAMPS	QUANTITY	LED
	WATTS	
	TOTAL WATTS	22 watts
ROTOR MOTOR		1 at 5 watts
HEIGHT, WIDTH, DEPTH		26 3/4 x 30 1/4 x 10 1/8
GLASS VIEWING OPENING		
SURROUND SIZE		32 1/2 x 25 5/8
SHIPPING SIZE	UNIT	30 x 35 3/4 x 13
	STEEL FRONT	30 x 35 x 3
SHIPPING WEIGHT	UNIT	61.6 lbs
	STEEL FRONT	15 lbs
PLUG LOCATION		Left Side
CORD LENGTH		76"
APPROX. HEATING AREA		400 sq ft

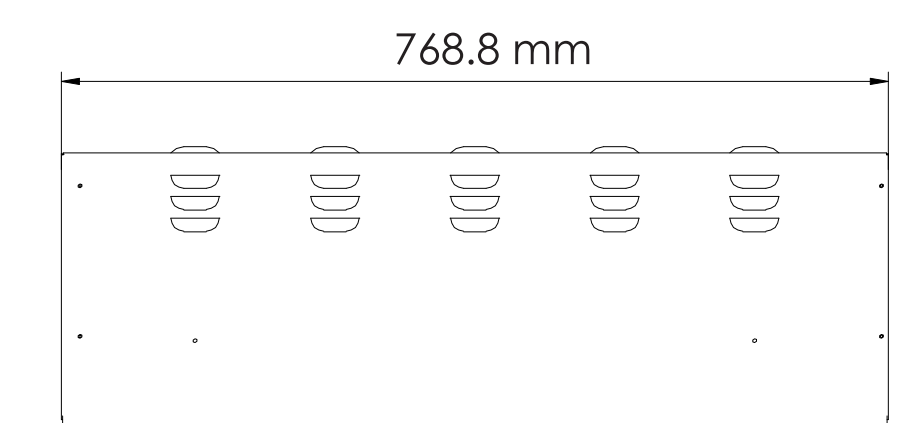

SERIES ZERO CLEARANCE	MODEL ZECL-31-3228-STL-ARCH		REV 1
SCALE 1" = 1'-0"	DATE: 12/1/15		SHEET 1 OF 1

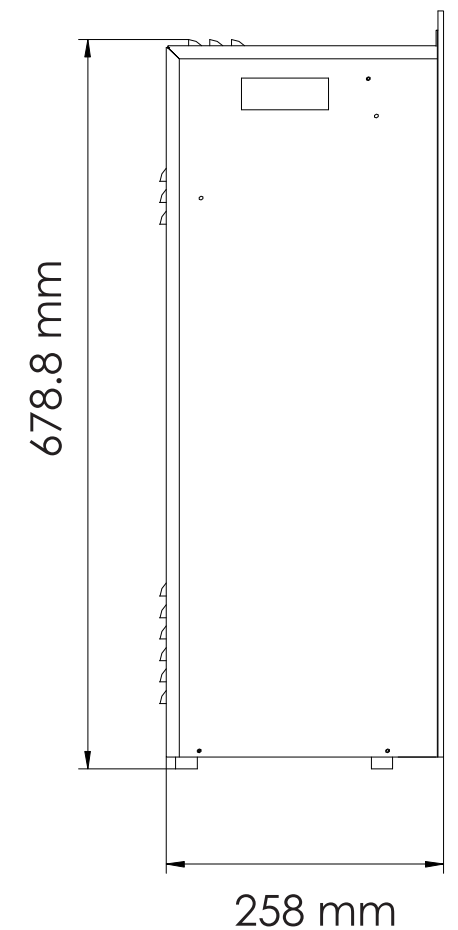
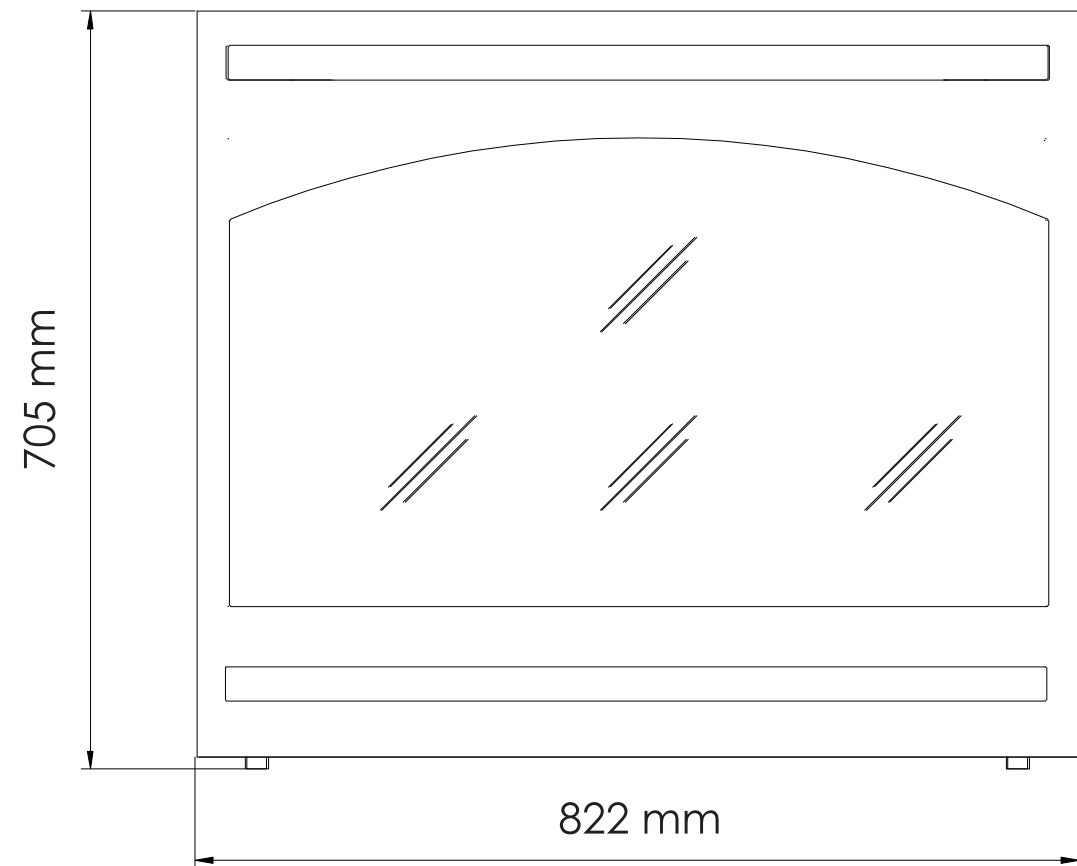

TECHNICAL SPECIFICATIONS		
VOLTS		120
AMPS		12.5
WATTS		1500
HEATER	HIGH	1500 watts
	LOW	750 watts
NO HEATER		22 watts
LAMPS	QUANTITY	LED
	WATTS	
	TOTAL WATTS	22 watts
ROTOR MOTOR		1 at 5 watts
HEIGHT, WIDTH, DEPTH		67.9 x 76.9 x 25.8 cm
GLASS VIEWING OPENING		
SURROUND SIZE		82.2 x 70.5 cm
SHIPPING SIZE	UNIT	76 x 90.5 x 32.5 cm
	STEEL FRONT	76 x 89 x 7.6 cm
SHIPPING WEIGHT	UNIT	28 kgs
	STEEL FRONT	7 kgs
PLUG LOCATION		Left Side
CORD LENGTH		193 cm
APPROX. HEATING AREA		37 sqm



SERIES ZERO CLEARANCE	MODEL ZECL-31-3228-STL-ARCH		REV 1
SCALE 1:12	DATE: 12/1/15		SHEET 1 OF 1