



TIMBERWOLF

Wood & Pellet

**ECONOMIZER**<sup>™</sup>  
STOVES & INSERTS

A rustic living room with a stone fireplace wall. A dark wood-burning stove with a tall chimney pipe is in the center. To the left is a brown leather sofa with patterned pillows. A window on the left shows a view of a field. A floor lamp with a white shade is on the right. The ceiling has a wooden beam and a ceiling fan.

The Timberwolf Economizer™ EPA wood stoves provide an economical solution to rising costs of home heating. These clean burning, cost effective stoves deliver the reliable heat you need. Outstanding efficiencies, a solid cast iron arched door and an impressive viewing area make Timberwolf stoves a perfect choice for your home or cottage. Available in three sizes to suit your specific heating requirements.

# ECONOMIZER™ EPA WOOD STOVES

EPA 2100  
Timberwolf  
52,000 BTU'S



Outstanding  
**85.5%**  
Efficiency Rating

EPA Wood Burning Stove shown with  
optional leg and ash pan kit

EPA 2200  
Timberwolf  
65,000 BTU'S



Outstanding  
**86%**  
Efficiency Rating

EPA Wood Burning Stove shown with  
optional pedestal and ash pan kit

EPA 2300  
Timberwolf  
85,000 BTU'S



Outstanding  
**83.9%**  
Efficiency Rating

EPA Wood Burning Stove shown with  
standard pedestal and ash pan kit

- EPA Certified
- All stoves come standard with a fully refractory lined firebox and painted black cast iron door
- Conveniently located air control lever

- Optional blower kit
- Optional ash pan (ash pan with lid included with 2300)
- Optional leg or pedestal kit (pedestal included with 2300)

Model	BTU Heat Output (high burn)*	Firebox Capacity (cu ft)	Area Heated** (sq ft)	Burn Time (hours)	Log Size (max)	Emissions (grams per hour)	Flue Diameter Top	Blower Kit Available
2100	52,000	1.5	500 - 1,500+	6 hrs	18"	3.9	6"	Yes
2200	65,000	1.9	800 - 2,000+	8 hrs	18"	3.6	6"	Yes
2300	85,000	3	1,000 - 3,500+	12 hrs	20"	2.9	6"	Yes

\*Wolf Steel Ltd. own test results showing realistic BTU using hardwood logs with regular refueling. Heat output will differ on chimney draft as well as type, moisture content and size of wood.

\*\*Figures may vary with individual conditions such as floor plan layout, insulation value/heat loss of the house, geographical location and firewood used.



Transform your masonry fireplace into an efficient, clean burning and cost-effective heating source with Timberwolf's EPA 2201 wood insert. The large firebox design accommodates 18" logs and allows for a long 8 hour burn time.



# ECONOMIZER™ EPA 2201 WOOD INSERT

EPA 2201  
Timberwolf

Outstanding  
**86%**  
Efficiency Rating

EPA Wood Burning Insert



- EPA Certified
- Heats from 800 to 2,000+ sq. ft.
- Large ceramic glass viewing area
- Firebox capacity of 1.9 cu. ft.
- Up to 65,000 BTU's
- Minimum fireplace opening: 25<sup>7/8</sup>" w x 22" h x 14" d
- Painted black cast iron door included
- Dual blower system included
- Painted black flashing with 3<sup>1/2</sup>" depth adjustment for installation versatility (sold separately)

Model	BTU Heat Output (high burn)*	Firebox Capacity (cu ft)	Area Heated** (sq ft)	Burn Time (hours)	Log Size (max)	Emissions (grams per hour)	Flue Diameter Top	Blower Kit Available
2201	65,000	1.9	800- 2,000+	8 hrs	18"	3.6	6"	Included

\* Wolf Steel Ltd. own test results showing realistic BTU using hardwood logs with regular refueling. Heat output will differ on chimney draft as well as type, moisture content and size of wood.

\*\*Figures may vary with individual conditions such as floor plan layout, insulation value/heat loss of the house, geographical location and firewood used.



Designed for efficiency, performance and to provide an economical heating source, the TPS35 pellet stove and TPI35 pellet insert delivers comfortable heat for up to 2000 sq. ft. With a maximum of 30 hours burn time, you enjoy minimal maintenance and less refueling.



# ECONOMIZER™ PELLET STOVE AND INSERT

TPS35 (Pellet Stove)  
Timberwolf



Outstanding  
**76.3%**  
Efficiency Rating

TPI35 (Pellet Insert)  
Timberwolf



Outstanding  
**76.3%**  
Efficiency Rating

- EPA Exempt
- Shown with standard pedestal (TPS35 only)
- Optional hopper extension available (TPS35 only)  
(increases pellet capacity to 100lbs)
- Minimum fireplace opening: 22" w x 21" h with adjustable depth (10 1/2" to 12 1/2" (TPI35 only)

- Certified for use with 50/50 mix of pellets and corn
- Painted black cast iron door included

Model	BTU Heat Output (high burn)*	Hopper Capacity	Area Heated** (pellets)	Burn Time (hours)	Flue Diameter	Heat Exchanger
TPS35	38,250	45lbs	800 - 2,000+	30 hrs	3"	Yes
TPI35	38,250	45lbs	800 - 2,000+	30 hrs	3"	Yes

\* Wolf Steel Ltd. own test results showing realistic BTU with regular refueling. Small pellets will increase or decrease the stated burn times. Differences plus or minus 20% may occur depending on fuel quality.

\*\* Figures may vary with individual conditions such as floor plan layout, insulation value/heat loss of the house, geographical location and pellets used.



## Stove Clearances to Combustibles - 2100, 2200, 2300

2100 & 2200	SINGLE WALL CONNECTOR	DOUBLE WALL CONNECTOR
SIDEWALL (A)	19"	19"
SIDEWALL TO FLUE (B)	28 <sup>7</sup> / <sub>8</sub> "	28 <sup>7</sup> / <sub>8</sub> "
BACKWALL (C)	17 <sup>1</sup> / <sub>2</sub> "	12 <sup>1</sup> / <sub>2</sub> "
BACKWALL TO FLUE (D)	21"	16"
CORNER (E)	11"	7"
2300	SINGLE WALL CONNECTOR	DOUBLE WALL CONNECTOR
SIDEWALL (A)	22"	22"
SIDEWALL TO FLUE (B)	31 <sup>3</sup> / <sub>4</sub> "	31 <sup>3</sup> / <sub>4</sub> "
BACKWALL (C)	12"	12"
BACKWALL TO FLUE (D)	15 <sup>1</sup> / <sub>2</sub> "	15 <sup>1</sup> / <sub>2</sub> "
CORNER (E)	8"	8"

TPS35	SINGLE WALL CONNECTOR	DOUBLE WALL CONNECTOR
SIDEWALL (A)	6"	6"
SIDEWALL TO FLUE (B)	-	-
BACKWALL (C)	3"	3"
BACKWALL TO FLUE (D)	-	-
CORNER (E)	2"	2"

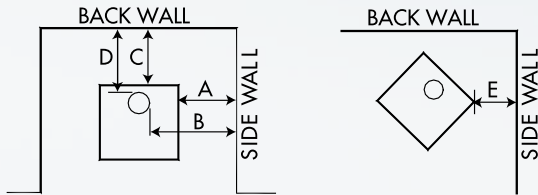

## Minimum Floor Protection

MODEL	FRONT (I)	SIDES (J)	BACK (K)
2100/2200/2300	18" (CAN)	8"	8"
	16" (US)		
TPS35	6"	6"	3"

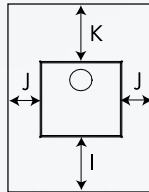

**NOTE:** If a section of horizontal chimney connector is used, floor protection is required under the chimney connector and 2" beyond each side.

You may decrease the minimum clearances to combustible materials with permanently installed heat radiation shields between the walls or the ceiling and the appliance. All shielding must be acceptable to local authorities.



## Insert Minimum Clearance To Combustibles - 2201, TPI35

	2201	TPI35
SIDEWALL (A)	16"	8"
MANTEL (B)	30"	8"
TOP FACING (C)	22"	6 <sup>3/8</sup> "
SIDE FACING (D)	10"	6"
HEARTH FRONT (E)	22"	6"
HEARTH SIDE (F)	8"	6"
OBJECTS IN FRONT OF INSERT (G)	48"	-

**2201** - Minimum fireplace opening: 25 <sup>7/8</sup>"w x 22"h x 14"d

**TPI35** - Minimum fireplace opening: 22"w x 21"h with adjustable depth (10 <sup>1/2</sup>" to 12 <sup>1/2</sup>"d)

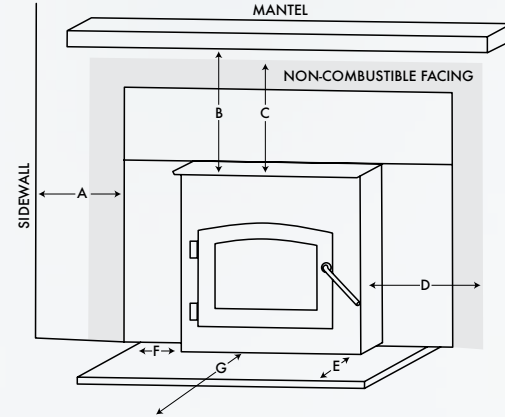

Wolf Steel, Manufacturer of Timberwolf Thinkers

# GREEN



# Dimensions

2100

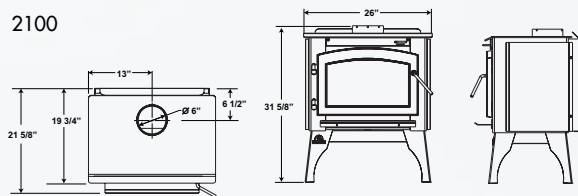

2201

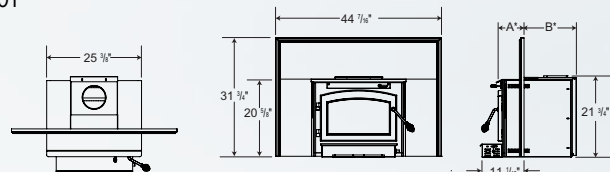

\*A: Min. Depth 4" - Max Depth 7 1/2" \*B: Min. Depth 14" - Max Depth 17 1/2"

2200

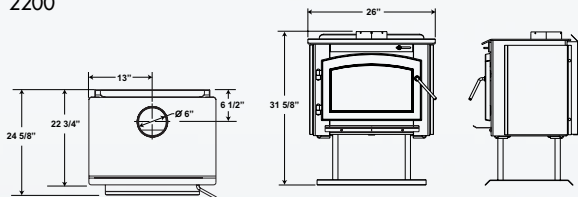

TPS35

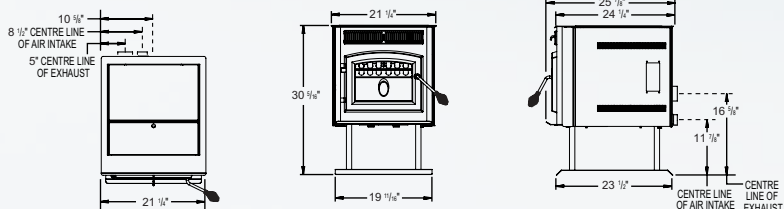

2300

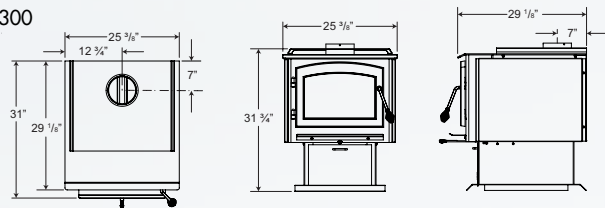

TPI35

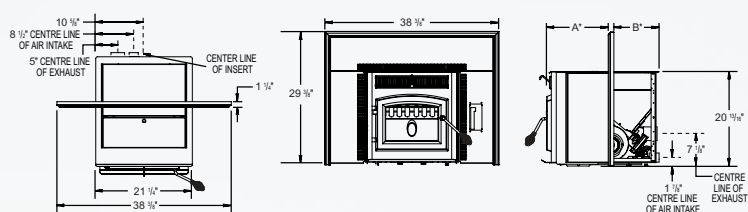

\*A: Adjustable 11" to 13" \*B: Adjustable 10 1/2" to 12 1/2"

## **The Philosophy:**

Wolf Steel cares about the environment in which we all live. Part of our commitment is to consider the overall impact of Timberwolf products on that environment. Factors such as design, production and even recyclable materials are all important considerations in creating EcoGreen products. At Wolf Steel, we pride ourselves in paying close attention to these important factors.

## **The Product:**

Timberwolf wood burning products are designed to meet EPA (Environmental Protection Agency) clean burning emission standards. The development of products which burn other alternate renewable fuels are continually being explored by our research and development team. Wolf Steel manufactures EcoGreen products to provide our customers with the utmost in comfort and safety both in their homes and in the environment. Wolf Steel was the first manufacturer to recognize and promote zone heating as a unique performance benefit that is provided by hearth products. Both non and renewable natural resources are better utilized by heating only the specific “occupied” area of the home. Heating your home with a Timberwolf, EPA (Environmental Protection Agency) approved stove or insert releases no more carbon dioxide than a dying tree would lying on the forest floor. In fact, when the entire carbon cycle is considered, a Timberwolf EPA approved product heats your home more efficiently and with less impact on the environment than any other heating fuel option. TPS35 and TPI35 pellet units are EPA certified as exempt.

## **The Manufacturing Process:**

Wolf Steel’s continuous improvement program includes a team specifically dedicated to reducing waste and improving our ‘green’ endeavors.

*The results speak for themselves:*

- Utilizing environmentally friendly chemicals in the production process while phasing out unfriendly ones
- Switching to citrus based, biodegradable cleaning agents to degrease steel in place of mineral based cleaners
- Converting from hydraulic to environmentally friendly electrical equipment
- Heating portions of the manufacturing facility with solar and biomass renewable energy heating technology
- Introducing natural binding agents as an alternative to silica in our fibre products
- Motion sensing, high efficiency warehouse lighting conserves electricity
- Over 95% of all finished goods are made with materials which can be recycled such as steel and glass

## **The Future:**

In addition to the use of recycled packaging materials, reusable containers and partnering with suppliers who practice similar Eco Friendly philosophies, Wolf Steel’s carbon footprint is continually being monitored and reduced, protecting the environment for you, our customers and future generations.



**Go Green  
With Timberwolf**



103 Miller Drive, Crittenden, Kentucky, USA 41030  
24 Napoleon Road, Barrie, Ontario, Canada L4M 4Y8  
7200 Trans Canada Highway, Montreal, Quebec, Canada H4T 1A3  
Tel: 705-721-1212 Fax 705-722-6031

[timberwolffireplaces.com](http://timberwolffireplaces.com)



CERTIFIED UNDER U.S. ENVIRONMENTAL PROTECTION AGENCY (E.P.A.) JULY 1990 40 C.F.R. PART 60 AND THE OREGON DEPARTMENT OF ENVIRONMENTAL QUALITY (D.E.Q.) PARTICULATE EMISSION STANDARDS BY EEMC (2300). THESE STOVES AND INSERTS HAVE BEEN TESTED AND LISTED TO EITHER EEMC, OMNI AND/OR INTERTEK STANDARDS: CSA B366.2, ULC S627, UL 1482. Consult your owner's manual for complete installation instructions and check all local and national building codes. All specifications and designs are subject to change without notice to allow for on-going product improvement. Images may not be exactly as shown. © Wolf Steel Ltd.

Authorized Dealer

Printed in Canada  
ADB480-11/10