



HEARTH PRODUCTS

P/N 506025-06 Rev. D 09/2012

This manual is one of a set of two supporting this product. Refer to P/N 506023-14 for Installation Instructions. Ce manuel est disponible en français, simplement en faire la demande. Numéro de la pièce 506223-35.

CARE AND OPERATION INSTRUCTIONS

Rhapsody™ Linear Direct-Vent Gas Fireplace



MODELS

RHAP42N

RHAP54N

infiniflame™

WHAT'S INSIDE

Table of Contents	2
Safety and Your Fireplace	2
FREE Safety Guard Offer (Protects Against Burns)	2
Important Safety Information	4
Attaching the Safety-in-Operation Warnings	5
[EN FRANÇAIS] L'information de sûreté importante	3-4
Apposition des mises en garde relatives à la sécurité d'utilisation	5
[EN ESPAÑOL] Información importante de seguridad	3-4
Colocación de advertencias de seguridad en operación	5



Intertek Report No. 100404899PRT-001

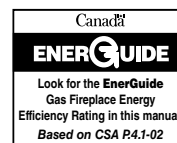
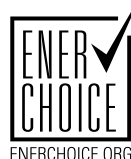

INSTALLER: Leave this manual with the appliance.
CONSUMER: Retain this manual for future reference.
INSTALLATEUR : Laissez cette notice avec l'appareil.
CONSOMMATEUR : Conservez cette notice pour consultation ultérieure.



! WARNING / AVERTISSEMENT / AVISO

**HOT GLASS WILL CAUSE BURNS.
DO NOT TOUCH GLASS UNTIL COOLED
NEVER ALLOW CHILDREN TO TOUCH GLASS.**



**UNE SURFACE VITRÉE CHAUDE PEUT CAUSER DES BRÛLURES.
LAISSER REFFROIDIR LA SURFACE VITRÉE AVANT D'Y TOUCHER.
NE PERMETTEZ JAMAIS À UN ENFANT DE TOUCHER LA SURFACE VITRÉE.**

**EL VIDRIO CALIENTE CAUSARÁ QUEMADURAS.
USTED DEBE NUNCA TOCAR EL VIDRIO CALIENTE.
LOS NIÑOS DEBEN NUNCA TOCAR EL VIDRIO.**

WARNING: If the information in these instructions is not followed exactly, a fire or explosion may result, causing property damage, personal injury, or death.

- Do not store or use gasoline or other flammable vapors and liquids in the vicinity of this or any other appliance.
- **WHAT TO DO IF YOU SMELL GAS:**
 - Do not try to light any appliance.
 - Do not touch any electrical switch; do not use any phone in your building.
 - Immediately call your gas supplier from a neighbor's phone. Follow the gas supplier's instructions.
 - If you cannot reach your gas supplier, call the fire department.
- Installation and service must be performed by a qualified installer, service agency or the gas supplier.

AVERTISSEMENT : Assurez-vous de bien suivre les instructions données dans cette notice pour réduire au minimum le risque d'incendie ou d'explosion ou pour éviter tout dommage matériel, toute blessure ou la mort.

- Ne pas entreposer ni utiliser d'essence ni d'autres vapeurs ou liquides inflammables dans le voisinage de cet appareil ou de tout autre appareil.
- **QUE FAIRE SI VOUS SENTEZ UNE ODEUR DE GAZ :**
 - Ne pas tenter d'allumer d'appareil.
 - Ne touchez à aucun interrupteur. Ne pas vous servir des téléphones se trouvant dans le bâtiment où vous trouvez.
 - Appelez immédiatement votre fournisseur de gaz depuis un voisin. Suivez les instructions du fournisseur.
 - Si vous ne pouvez rejoindre le fournisseur de gaz, appelez le service des incendies.
- L'installation et l'entretien doivent être assurés par un installateur ou un service d'entretien qualifié ou par le fournisseur de gaz.

Thank you for your purchase. We appreciate your business!
 Please carefully read and follow all instructions in this manual.
Pay special attention to all warnings and safety information.
 Following these safety, care, and operation instructions will help ensure many years of dependable and enjoyable service from your fireplace.

Register your product online today!

To help us keep you up-to-date on product information and offers, please take a few moments to register your product online at www.LennoxHearthProducts.com (>Owner Resources>Product Registration).

• FREE SAFETY GUARD OFFER •
The Lennox® SAFETY GUARD protects against severe burns and injuries by preventing direct contact with the front glass surface of your fireplace.
 To receive your FREE SAFETY GUARD, call 1-800-655-2008 or visit www.LennoxHearthProducts.com (>Buying Guide>Safety First).
Note: Safety Guards may not be available for some older models that are no longer in production.

TABLE OF CONTENTS

Safety and Your Fireplace 2
Important Safety Information 4
Attaching the Safety-in-Operation Warnings 5
 Appliance Installation, Service, and Maintenance Notices 6
 Appliance Operation Notices 6
 Warranty Information 6
 General Information 7
 Introduction 7
 Listing Standards 7
 Burn-In Period 7
 Operation and Care of Your Appliance 8
 Gas Shutoff Valve 8
 Service Shutoff Valve 8
 Lighting the Appliance 8
 Intermittent and Standing Pilot Modes 8
 Flame Appearance and Sooting 9
 Air Shutter Adjustment Guidelines 9
 Air Shutter Adjustment Procedure 9
 Total Comfort Control™ Remote Control System 10
 Maintenance Procedures 12
 Installation/Removal of Glass Door and Modesty Panel 13
 Installation/Removal of Optional Bezel 14
 Lighting and Operation Instructions 15
 [Instructions d'allumage] 16
 Maintenance Schedule 17
 Troubleshooting Guide 18
 Accessories 19
 Replacement Parts 20
 Product Reference Information 20

NATIONAL FIREPLACE INSTITUTE

CERTIFIED
www.nficertified.org

We recommend that our gas hearth products be installed and serviced by professionals who are certified in the U.S. by the National Fireplace Institute® (NFI) as NFI Gas Specialists.

Safety and Your Fireplace

All parts of your Lennox Hearth Products fireplace get EXTREMELY HOT!

- To prevent severe burns and injuries, install a screen or physical barrier to prevent direct contact with the glass.

To order a FREE Lennox® SAFETY GUARD for your fireplace, see details at left.

- Follow the safety instructions below and be sure everyone in your household understands this burn hazard:

- The surfaces on your fireplace get **EXTREMELY HOT!**

- The glass on the front of the fireplace reaches **EXTREMELY HIGH** temperatures and can cause severe burns if touched.



- Keep children away from an operating fireplace. Closely supervise children in any room where a fireplace is operating to prevent contact with glass.

- Keep clothing, furniture, gasoline, and other flammable liquids away from the fireplace.



- Even after the gas is turned off, fireplace surfaces remain extremely hot.

- Be sure to attach the enclosed **Safety-in-Operation Warnings** where you turn on your fireplace, to help remind everyone of the dangers associated with high temperatures (see **Page 5**).

- Read **Important Safety Information** on **Page 4**.

[FRENCH]

La sécurité et votre foyer

Toutes les parties de votre foyer Lennox Hearth Products deviennent EXTRÊMEMENT CHAUDES !

- Afin d'éviter de vous brûler gravement ou de vous blesser, installez une grille ou une barrière physique pour empêcher tout contact direct avec la vitre.

Pour commander un PANNEAU DE PROTECTION Lennox® GRATUIT pour votre foyer, consultez les détails dans la partie gauche.

- Suivez les instructions de sécurité ci-dessous et veillez à ce que tous les membres de votre famille soient conscients du danger de brûlure encouru :

- Les surfaces de votre foyer deviennent **EXTRÊMEMENT CHAUDES !**
- La vitre située à l'avant du foyer atteint des températures **EXTRÊMEMENT ÉLEVÉES** et peut causer de graves blessures en cas de contact.
- Tenez les enfants à l'écart du foyer lorsqu'il fonctionne. Surveillez attentivement les enfants dans les pièces où un foyer est utilisé afin d'éviter qu'ils ne soient en contact avec la vitre.
- Tenez tous les vêtements, les meubles, l'essence et tout autre liquide inflammable à l'écart du foyer.
- Même après fermeture du gaz, les surfaces du foyer restent extrêmement chaudes.

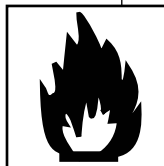

- Veillez à coller les **Étiquettes de mise en garde relatives à la sécurité d'utilisation** à l'endroit où vous utilisez le foyer, pour rappeler à tous les utilisateurs les dangers liés aux températures élevées (**voir Page 5**).
- Lisez la section **Informations importantes relatives à la sécurité, Page 4**.

[SPANISH]

Seguridad y su chimenea

¡Todas las partes de la chimenea Lennox Hearth Products se ponen MUY CALIENTES!

- Instale una malla o barrera física para evitar el contacto directo con el vidrio y prevenir las quemaduras y lesiones graves.

Ver los detalles a la izquierda para ordenar un Lennox® SAFETY GUARD GRATIS para su chimenea.

- Siga las instrucciones de seguridad a continuación y asegúrese de que todos en su hogar sepan acerca de este peligro de quemadura:

- **¡Las superficies de la chimenea se ponen MUY CALIENTES!**
- El vidrio delante de la chimenea alcanza temperaturas **EXTREMADAMENTE ALTAS** y puede causar quemaduras graves si se toca.
- Mantenga a los niños alejados de la chimenea en funcionamiento. Supervise en forma cercana a los niños en cualquier cuarto donde haya una chimenea funcionando para impedir el contacto con el vidrio.
- Mantenga la ropa, mobiliario, gasolina y otros líquidos inflamables alejados de la chimenea.
- Aún después de haber apagado el gas, las superficies de la chimenea permanecen extremadamente calientes.

- Asegúrese de colocar las **Etiquetas de advertencia de seguridad de operación** en el lugar donde enciende la chimenea, para que todos recuerden los peligros asociados con las altas temperaturas (**ver la página 5**).
- Lea la **Información importante** de seguridad en la **página 4**.

Important Safety Information

1. **WARNING:** Do not operate appliance with the glass front removed, cracked or broken.
2. Do not use this appliance if any part has been under water. Immediately call a qualified service technician to inspect the appliance and to replace any part of the control system and any gas control which has been under water.
3. Due to high temperatures, the appliance should be located out of traffic and away from furniture and draperies.
4. Children and adults should be alerted to the hazards of high surface temperature and should stay away to avoid burns or clothing ignition.
5. Clothing or other flammable material should not be placed on or near the appliance.
6. Young children should be carefully supervised when they are in the same room as the appliance. Toddlers, young children, and others may be susceptible to accidental contact burns. A physical barrier is recommended if there are at-risk individuals in the house. To restrict access to a fireplace or stove, install an adjustable safety gate to keep toddlers, young children, and other at-risk individuals out of the room and away from hot surfaces.
7. Any safety screen or guard removed for servicing an appliance must be replaced prior to operating the appliance.
8. Installation and repair should be done by a qualified service person. The appliance should be inspected before use and at least annually by a professional service person. More frequent cleaning may be required due to excessive lint from carpeting, bedding material, et cetera. It is imperative that control compartments, burners, and circulating air passageways of the appliance be kept clean. See maintenance instructions on *Page 12*.

L'information de sûreté importante

1. **AVERTISSEMENT.** Ne pas utiliser l'appareil si le panneau frontal en verre n'est pas en place, est craqué ou brisé.
2. Ne pas utiliser cet appareil s'il a été plongé, même partiellement, dans l'eau. Appeler un technicien qualifié pour inspecter l'appareil et remplacer toute partie du système de commande et toute commande qui a été plongée dans l'eau.
3. En raison des températures élevées, l'appareil devrait être installé dans un endroit où il y a peu de circulation et loin du mobilier et des tentures.
4. Les enfants et les adultes devraient être informés des dangers que posent les températures de surface élevées et se tenir à distance afin d'éviter des brûlures ou que leurs vêtements ne s'enflamment.
5. On ne devrait pas placer de vêtements ni d'autres matières inflammables sur l'appareil ni à proximité.
6. Les jeunes enfants devraient être surveillés étroitement lorsqu'ils se trouvent dans la même pièce que l'appareil. Les tout petits, les jeunes enfants ou les adultes peuvent subir des brûlures s'ils viennent en contact avec la surface chaude. Il est recommandé d'installer une barrière physique si des personnes à risques habitent la maison. Pour empêcher l'accès à un foyer ou à un poêle, installez une barrière de sécurité ; cette mesure empêchera les tout petits, les jeunes enfants et toute autre personne à risque d'avoir accès à la pièce et aux surfaces chaudes.
7. Tout écran ou protecteur retiré pour permettre l'entretien de l'appareil doit être remis en place avant de mettre l'appareil en marche.
8. L'installation et la réparation devrait être confiées à un technicien qualifié. L'appareil devrait faire l'objet d'une inspection par un technicien professionnel avant d'être utilisé et au moins une fois l'an par la suite. Des nettoyages plus fréquents peuvent être nécessaires si les tapis, la literie, et cetera produisent une quantité importante de poussière. Il est essentiel que les compartiments abritant les commandes, les brûleurs et les conduits de circulation d'air de l'appareil soient tenus propres. Voyez les instructions d'entretien à la *page 12*.

[SPANISH]

Información importante de seguridad

1. **ADVERTENCIA:** No opere el artefacto con el frente de vidrio quitado, agrietado o roto.
2. No use este artefacto si alguna de sus partes ha estado bajo agua. Llame de inmediato a un técnico de servicio calificado para que inspeccione el artefacto y reemplace cualquier parte del sistema de control y cualquier control de gas que haya estado bajo agua.
3. Debido a las altas temperaturas, el artefacto debe situarse fuera de las áreas de tráfico y lejos del mobiliario y cortinas.
4. Se debe alertar a los niños y adultos sobre los peligros de las altas temperaturas en la superficie y que se mantengan alejados para evitar quemaduras o ignición de la ropa.
5. No debe colocarse ropa u otros materiales inflamables sobre y cerca del artefacto.

6. Se debe supervisar de cerca a los niños cuando estén en el mismo cuarto que el artefacto. Los niños pequeños, los jóvenes y otras personas pueden ser susceptibles a quemaduras por contacto accidental. Se recomienda instalar una barrera física si hay personas en riesgo en la casa. Para restringir el acceso a una chimenea o estufa, instale una puerta de seguridad ajustable para mantener a los niños pequeños, jóvenes y otras personas en riesgo fuera del cuarto y lejos de las superficies calientes.
7. Cualquier malla o resguardo de seguridad quitado para dar servicio a un artefacto, debe reinstalarse antes de operar el artefacto.
8. Una persona de servicio competente debe realizar la instalación y reparación. Una persona de servicio profesional debe inspeccionar el artefacto antes de usar al menos una vez por año. Se puede requerir limpieza más frecuente debido a la pelusa excesiva del alfombrado, del material de cobijas, etc. Es imprescindible mantener limpios los compartimientos de control, los quemadores y los pasajes de circulación del aire del artefacto. Ver las instrucciones de mantenimiento en la *página 12*.

HOMEOWNER'S INSTRUCTIONS - ATTACHING "SAFETY-IN-OPERATION" WARNINGS

ATTACHING SAFETY-IN-OPERATION WARNINGS

Your fireplace has been furnished with safety instruction labels that are to be affixed to the operation and control points of the fireplace. A safety instruction label should be affixed to the receiver wall switch plate where the fireplace is turned on and off (*See Figure A*) and the remote control handheld transmitter (*Figure B*). The warnings should already have been put in place when the fireplace initial set-up was completed. If they are not affixed at these spots, locate the multi-lingual adhesive labels provided with these instructions and proceed as follows:

1. Locate the wall receiver that controls the fireplace (verify the switch operates the fireplace by turning it on and off). Clean the wall receiver plate thoroughly to remove any dust and oils. Affix the label to the surface of the plate of the wall receiver that controls the fireplace (*Figure A*). Choose the language primarily spoken in the home.
2. Locate the remote control transmitter and clean it thoroughly to remove any dust and oils. Affix the label to the surface of handheld transmitter (*Figure B*). Choose the language primarily spoken in the home.
3. If you are unable to locate the labels, please call Lennox Hearth Products or your nearest Lennox Hearth Products dealer to receive additional safety instruction labels free of charge.

Cat. No. H8024 Replacement Label Kit

LENNOX HEARTH PRODUCTS

1-800-655-2008

Note: English is red text on clear label. French and Spanish are white text on black label.

APPOSITION DES MISES EN GARDE RELATIVES À LA SÉCURITÉ D'UTILISATION

Votre foyer a été livré avec des étiquettes de sécurité qui doivent être collées à côté des dispositifs de contrôle du foyer. Une étiquette de sécurité devrait être collée sur la plaque du récepteur mural contrôlant l'allumage du foyer (*voir Figure A*) et sur le boîtier de la télécommande (*Figure B*). Les mises en garde auraient dû être collées au moment de l'installation initiale du foyer. Si ce n'est pas le cas, prenez les étiquettes adhésives multilingues fournies avec ces instructions et procédez comme suit:

1. Repérez le récepteur mural qui contrôle le foyer (vérifiez que l'interrupteur contrôle le fonctionnement du foyer en le faisant basculer de Marche à Arrêt, et vice-versa). Nettoyez soigneusement la plaque du récepteur mural pour éliminer la poussière et les traces de graisse ou d'huile. Collez l'étiquette sur la surface de la plaque du récepteur mural qui contrôle le foyer (*Figure A*). Choisissez la langue qui est principalement parlée dans la résidence du propriétaire.
2. Repérez la télécommande et nettoyez-la soigneusement pour éliminer la poussière et les traces de graisse ou d'huile. Collez l'étiquette sur le boîtier de la télécommande (*Figure B*). Choisissez la langue qui est principalement parlée dans la résidence du propriétaire.
3. Si vous ne trouvez pas les étiquettes, veuillez appeler Lennox Hearth Products ou votre distributeur Lennox Hearth Products local pour recevoir gratuitement des étiquettes supplémentaires.

Étiquettes de remplacement, n° cat. H8024

LENNOX HEARTH PRODUCTS

1-800-655-2008

Remarque : Le texte anglais est rouge sur un support transparent. Le texte français et espagnol est blanc sur un support noir.

COLOCACIÓN DE ADVERTENCIAS DE SEGURIDAD EN OPERACIÓN

Su chimenea incluye etiquetas de instrucciones de seguridad que deben colocarse en los puntos de operación y control de la chimenea. Se debe colocar una etiqueta de instrucciones de seguridad en la placa del interruptor de pared del receptor desde el cual se enciende y se apaga la chimenea (*ver la Figura A*) y en el transmisor de control remoto (*Figura B*). Las advertencias ya deben haberse colocado cuando se completó la instalación inicial de la chimenea. Si no están colocadas en estos lugares, encuentre las etiquetas adhesivas multilingües proporcionadas con estas instrucciones y prosiga de la siguiente manera:

1. Identifique el receptor de pared que controla la chimenea (verifique que el interruptor opera la chimenea encendiéndola y apagándola). Limpie bien la placa del receptor de pared para quitar el polvo y aceite. Pegue la etiqueta en la superficie de la placa del receptor de pared que controla la chimenea (*Figura A*). Seleccione el idioma que más se habla en la casa.
2. Identifique el transmisor de control remoto y límpielo bien para quitar el polvo y aceite. Pegue la etiqueta en la superficie del transmisor (*Figura B*). Seleccione el idioma que más se habla en la casa.
3. Si no puede encontrar las etiquetas, sírvase llamar a Lennox Hearth Products o al distribuidor de Lennox Hearth Products más cercano para recibir etiquetas de instrucciones de seguridad adicionales gratuitas.

Juego de etiquetas de repuesto - N° de cat. H8024

LENNOX HEARTH PRODUCTS

1-800-655-2008

Nota: La etiqueta en inglés es transparente con texto rojo. Las etiquetas en francés y español son negras con texto blanco.

SAFETY LABEL DIAGRAMS / DIAGRAMAS DE ETIQUETAS DE SEGURIDAD / DIAGRAMMES DES ÉTIQUETTES DE SÉCURITÉ



Figure A

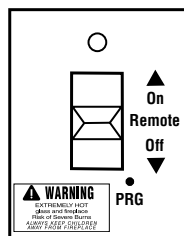

Figure B



APPLIANCE INSTALLATION, SERVICE, AND MAINTENANCE NOTICES

WARNING: Improper installation, adjustment, alteration, service, or maintenance can cause injury or property damage. Refer to owner's information manual provided with this appliance. For assistance or additional information, consult a qualified installer, service agency or the gas supplier.

AVERTISSEMENT : Une installation, un réglage, une modification, une réparation ou un entretien mal effectué peut causer des dommages matériels ou des blessures. Voir la notice de l'utilisateur qui accompagne l'appareil. Pour de l'aide ou des renseignements supplémentaires, consultez un installateur, un technicien agréé ou le fournisseur de gaz.

Only accessory kit(s) supplied by the manufacturer shall be used in the installation of this appliance.

Only trim kit(s) supplied by the manufacturer shall be used in the installation of this appliance.

Seules les trousse de garniture fournies par le fabricant doivent être utilisées pour l'installation de cet appareil.

These appliances must not be connected to a chimney or flue serving a separate solid fuel burning appliance.

Any change to this appliance and/or its operating controls is dangerous. Improper installation or use of this appliance can cause serious injury or death from fire, burns, explosion or carbon monoxide poisoning.

CARBON MONOXIDE POISONING: Early signs of carbon monoxide poisoning are similar to the flu with headaches, dizziness and/or nausea. If you have these signs, obtain fresh air immediately. Turn off the gas supply to the appliance and have it serviced by a qualified professional, as it may not be operating correctly. Some people are more affected by carbon monoxide than others, including pregnant women, people with heart or lung disease or anemia, those under the influence of alcohol, and those at high altitudes.

Turn off gas and electrical power to the fireplace and allow it to cool before cleaning or servicing the appliance.

The vent termination is hot while in operation and for a period of time following the use of the fireplace. Young children should be carefully supervised when they are in the same area as a hot termination.

APPLIANCE OPERATION NOTICES

Do not operate appliance with the glass front removed, cracked, or broken.

These fireplaces are vented gas appliances. Do not burn wood or other material in these appliances.

This appliance is only for use with the type of gas indicated on rating plate. This appliance is not convertible for use with other gases, unless a certified kit is used.

Cet appareil doit être utilisé uniquement avec les types de gaz indiqués sur la plaque signalétique. Ne pas l'utiliser avec d'autres gaz sauf si un kit de conversion certifié est installé.

These appliances are designed to operate on natural gas or propane gas only. The use of other fuels or combinations of fuels will degrade the performance of this system and may be dangerous.

Provide adequate clearances around air openings and adequate accessibility clearance for service and proper operation. Never obstruct the front openings of the appliance.

Do not use this appliance if any part has been under water. Immediately call a qualified service technician to inspect the appliance and to replace any part of the control system and any gas control that has been under water.

These fireplaces are designed as supplemental heaters. Therefore, it is advisable to have an alternate primary heat source when installed in a dwelling.

CAUTION: Hot while in operation. Do not touch. Severe Burns may result. Keep children, clothing furniture, gasoline and other liquids having flammable vapors away.

ATTENTION : L'appareil est chaud lorsqu'il fonctionne. Ne pas toucher l'appareil. Risque de brûlures graves. Surveiller les enfants. Garder les vêtements, les meubles, l'essence ou autres liquides produisant des vapeur inflammables loin de l'appareil.

WARRANTY INFORMATION

Your gas appliance is covered by a limited lifetime warranty. You will find a copy of the warranty accompanying this manual. Please read the warranty to be familiar with its coverage.

Retain this manual. File it with your other documents for future reference.

Failure to comply with the installation and operating instructions provided will result in an improperly installed and operating appliance, voiding its warranty.

Do not attempt to alter or modify the construction of the appliance or its components. Any modification or alteration may void the warranty, certification, and listings of this unit.

GENERAL INFORMATION

Introduction

LENNOX HEARTH PRODUCTS Rhapsody™ models are direct-vent (top vent only), sealed combustion, air-circulating gas fireplaces designed for residential applications.

Direct-vent appliances operate with the combustion chamber isolated from the indoor environment. All air for combustion is brought in from the outside, and exhaust gases are vented through the same direct-vent, coaxial (intake/exhaust) vent system.

These appliances are designed to operate on natural or propane gas only. The use of other fuels or fuel combinations will degrade the performance of this system, may be dangerous, and may void the warranty.

The electronic system is switchable between standing and intermittent pilot modes.

The **Total Comfort Control™ Remote Control System** is included with all models and provides remote operation of several fireplace functions (manual adjustment of the gas valve settings is not possible). See **Page 10** for details.

Electrical power (120V AC line voltage) is recommended to operate the fireplace; however, “AA” batteries can be used for full-time operation or as a backup in case of a power outage.

Note:

Batteries will operate the gas valve OPEN/CLOSE and pilot ON/OFF functions only.

Electrical power (120V AC line voltage) is REQUIRED to operate the following optional components (batteries will not power any of these options):

- Blower Kit
- Power Vent System
- Panel Backlighting Kit

Refer to the fireplace *Installation Instructions** for the following information:

- Installation Code Requirements
- Inputs and Efficiencies
- Gas Supply Pressure Requirements
- Burner Orifice Sizes
- Burner Adjustment
- Gas Valve Illustration
- Wiring Diagram

* Fireplace *Installation Instructions* and other related manuals are available for download at: www.LennoxHearthProducts.com (>Owner Resources >Product Literature).

Listing Standards

These appliances comply with National Safety Standards and are tested and listed by Intertek (Report No. 100404899PRT-001) to ANSI Z21.88 (in Canada, CSA-2.33), and CAN/CGA-2.17-M91 (CSA P4.1) in both USA and Canada, as vented gas fireplace heaters.

These appliances are listed by Intertek for installation in bedrooms, aftermarket mobile homes, and manufactured homes.

Burn-in Period

The first few operations of this appliance will emit some odor due to paint curing and burn-off of lubricants used in the manufacturing process. Depending on your use, this burn-in period may last through several operations.

Note:

- **If the optional Blower Kit is installed, do NOT turn it on during the burn-in period.**
- **KEEP YOUR HOUSE WELL VENTILATED DURING THE BURN-IN PERIOD.** The odor and haze emitted during the burn-in period can be quite noticeable and may set off a smoke detector.

NOTICE:

A white film may develop on the glass enclosure panel during the first few fires as part of the burn-in process.

The first few times you use the fireplace, clean the glass after each use (AFTER THE GLASS HAS COMPLETELY COOLED); otherwise, the white film will bake onto the glass and become difficult to remove.

See glass cleaning instructions in the MAINTENANCE section of this manual.

OPERATION AND CARE OF YOUR APPLIANCE

Gas Shutoff Valve

As part of your fireplace installation, the installer may have provided a readily accessible gas shutoff valve near your fireplace. **Make sure this valve is fully OPEN before operating the fireplace.**

Service Shutoff Valve

If gas is not flowing to the pilot and burner, the **service shutoff valve** located in the fireplace control compartment (**Figure 1**) may need to be opened. Contact your dealer or distributor for more information.

To access the service shutoff valve:

Remove the bezel (if applicable), glass door, burner, floor panels, and control compartment access panel in the fireplace floor. Removal instructions are included in the fireplace *Installation Instructions*.

! WARNING

HOT GLASS WILL CAUSE BURNS. DO NOT TOUCH GLASS UNTIL COOLED.

- Fireplace surfaces get **EXTREMELY HOT!**
- The glass on the front of the fireplace reaches **EXTREMELY HIGH** temperatures and can cause severe burns if touched. Even after the gas is turned off, fireplace surfaces remain extremely hot.

Lighting the Appliance

To light the appliance, refer to the detailed lighting instructions on **Pages 15 and 16**. Lighting instructions are also provided on a tag attached to the fireplace door bracket.

Intermittent and Standing Pilot Modes

This appliance is fitted with a switch located below the control compartment access panel on the right side (**Figure 1**) that toggles between **intermittent** ignition (when in the OFF position) and **standing** pilot mode (when in the ON position).

- A **standing** pilot remains lit when the fireplace is off, and will aid cold-weather startup by keeping the flue and glass warm.
- **Intermittent** mode will save energy.

! WARNING

Young children should be carefully supervised when they are in the same room as the appliance. Toddlers, young children, and others may be susceptible to accidental contact burns. A physical barrier is recommended if there are at-risk individuals in the house. To restrict access to a fireplace or stove, install an adjustable safety gate to keep toddlers, young children, and other at-risk individuals out of the room and away from hot surfaces.

! AVERTISSEMENT

Les jeunes enfants devraient être surveillés étroitement lorsqu'ils se trouvent dans la même pièce que l'appareil. Les tout petits, les jeunes enfants ou les adultes peuvent subir des brûlures s'ils viennent en contact avec la surface chaude. Il est recommandé d'installer une barrière physique si des personnes à risques habitent la maison. Pour empêcher l'accès à un foyer ou à un poêle, installez une barrière de sécurité; cette mesure empêchera les tout petits, les jeunes enfants et toute autre personne à risque d'avoir accès à la pièce et aux surfaces chaudes.

[TOP VIEW, WITH FLOOR KIT REMOVED]

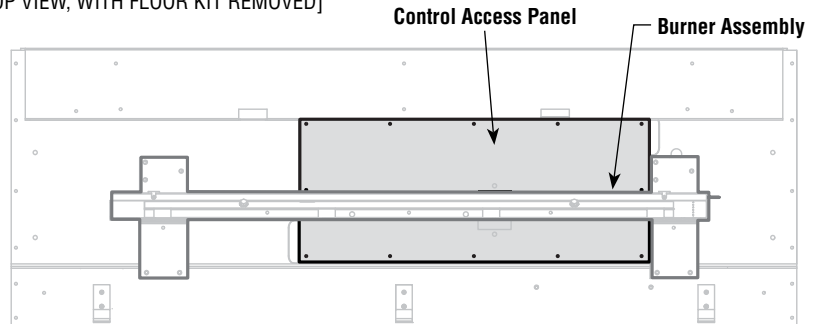

Fireplace Front

[DETAIL/CUTAWAY, WITH BURNER AND CONTROL ACCESS PANEL REMOVED]

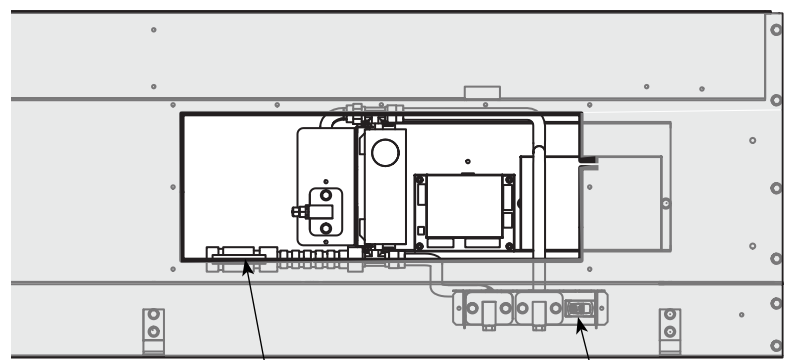

Service Shutoff Valve

CPI/IPI Switch*
(ON = Standing;
OFF = Intermittent)

*Switches from **intermittent** ignition to **standing** pilot mode (a standing pilot remains lit when the fireplace is off).

Figure 1

Flame Appearance and Sooting

Proper flame appearance is a flame that is blue at the base and becomes yellowish-orange in the body of the flame. When the appliance is first lit, the entire flame may be blue and will gradually turn yellowish-orange during the first 30 minutes of operation. After 30 minutes of operation, if the flame is blue, or if the flame is orange with evidence of sooting (black tip), the air shutter opening may need to be adjusted, changing the air-to-fuel mixture in the burner.

If the air shutter opening is closed too far, sooting may develop. Sooting is indicated by black puffs developing at the tips of very long orange flames. Sooting results in black deposits forming on the inside surfaces of the fireplace and on exterior surfaces adjacent to the vent termination.

Sooting is caused by incomplete combustion in the flames and lack of combustion air entering the air shutter opening. To achieve a warm yellowish-orange flame with an orange body that does not soot, the shutter opening must be adjusted between these two extremes.

Air Shutter Adjustment Guidelines

WARNING

- Air shutter adjustment should only be performed by a qualified professional service technician.
- Ensure glass door assembly is in place and sealed during adjustment.

- If there is smoke or soot present, first ensure that the flames are not touching any of the panels. If the panels are properly positioned and a sooting condition still exists, increase the air shutter opening.
- The more offsets in the vent system, the larger the air shutter opening will need to be.
- The length and configuration of the chimney vent will affect flame appearance.
- An appliance operated with the air shutter opened too far may have flames that appear blue and transparent. These weak, blue and transparent flames are termed *anemic*.
- Propane models may exhibit flames that candle or appear stringy. If this is present and persists, adjust the air shutter to a more OPEN position, then operate the appliance for a few more minutes to ensure that the flame normalizes and the flames do not appear sooty.



Figure 2: Proper Flame Appearance

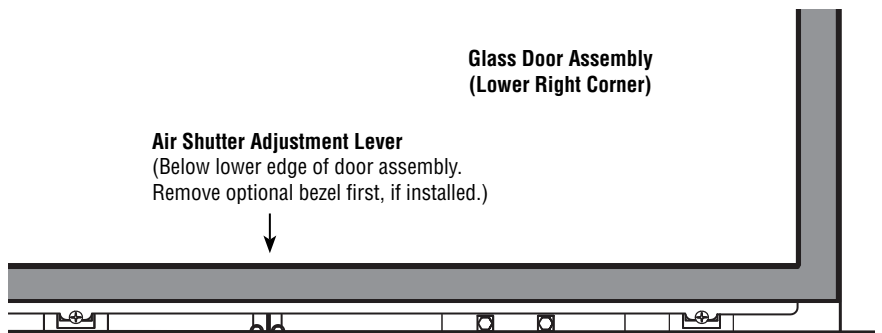

Figure 3: Air Shutter Adjustment Lever

The following chart is provided to aid you in achieving the correct air shutter adjustment for your installation:

Air Shutter Adjustment Guidelines		
Amount of Primary Air	Flame Color	Air Shutter Adjustment
If air shutter is closed too far →	Flame will be orange →	Air shutter gap should be increased
If air shutter is open too far →	Flame will be blue →	Air shutter gap should be decreased

CAUTION

- Soot will be produced if the air shutter is closed too much. Any damage due to sooting resulting from improperly setting the air shutter is not covered under the warranty.
- The air shutter door and nearby appliance surfaces are hot. Exercise caution to avoid injury while adjusting flame appearance.

Air Shutter Adjustment Procedure

To adjust the air shutter for proper flame appearance (as illustrated in Figure 2):

1. Before adjusting the air shutter, allow the burner to operate for at least 30 minutes while continuously observing the flame.
 2. Adjust the air shutter using the lever on the lower right side of the firebox (Figure 3).
 - For more CLOSED air shutter, PULL lever OUT (toward front of fireplace).
 - For more OPEN air shutter, PUSH lever IN (toward back of fireplace).
- If the flame appears weak or sooty, adjust the air shutter until proper flame appearance is achieved.
 - If the flame stays lowered blue, *incrementally* adjust the air shutter to a more CLOSED position until proper flame appearance is achieved.

TOTAL COMFORT CONTROL™ REMOTE CONTROL SYSTEM

The Total Comfort Control system included with your fireplace provides remote operation of the following fireplace functions:

- Burner ON/OFF
- Thermostat control and temperature setting
- Flame height and heat output adjustment (six levels)
- Blower speed adjustment (six levels) [for optional Blower Kit]
- Lighting ON/OFF [for optional Panel Backlighting Kit]

The receiver (**Figure 4**) is located behind the wall switchplate) and is powered by four AA batteries.

The wall switch can be set to one of three positions:

- **ON** (manual override)
- **OFF** (manual override)
- **REMOTE** (remote control)

The transmitter (handheld remote control) (**Figure 5**) sends commands via radio frequency to the receiver and does not require line-of-sight operation.

Initializing the Remote Control System

If not already done, the remote control system must be initialized before operating the fireplace.

1. Insert the (3) provided AAA batteries into the battery bay on the base of the handheld remote control, taking care to place them in the correct polarity direction (+/-).
2. Insert the (4) provided AA batteries into the wall switch battery bay (behind the switchplate), taking care to place them in the correct polarity direction (+/-).
3. Slide the wall switch to the **REMOTE** position (**Figure 4**).

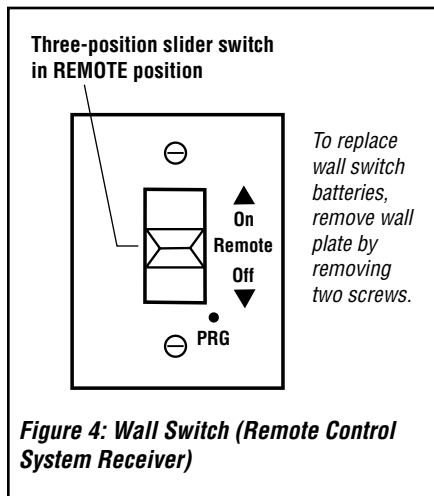

4. On the front of the switchplate, insert the end of a paper clip (or other similar object) into the hole marked "PRG." It will beep three times to indicate it is ready to synchronize with the remote control.

5. On the remote control, press the ON/OFF button.

The wall switch receiver will beep four times to indicate acceptance of the command (and set the wall switch receiver to the remote's specific code).

The system is now initialized.

Low Battery Power Detection

Battery life depends on several factors, including battery quality, number of fireplace ignitions, and number of thermostat temperature setting changes.

Wall Switch (Receiver) Battery Power

To test the batteries in the wall switch receiver, press the handheld remote control ON/OFF key one time.

- If the wall switch receiver emits a beep, the batteries have enough power.
- If the wall switch receiver does not emit a beep, remove the wall switchplate and replace the (4) AA batteries (see **Figure 4**).

Remote Control Battery Power

When the batteries in the handheld remote control are low, a battery icon will appear on the LCD screen (see **Figure 6, next page**) before battery power is lost.

When the (3) AAA batteries in the handheld remote control are replaced, the battery icon will disappear.

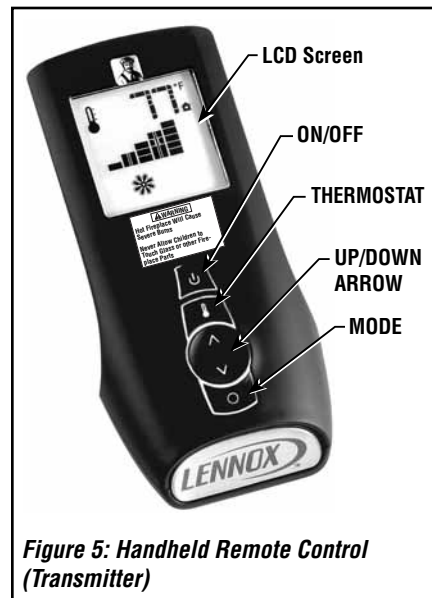

! WARNING

FIRE HAZARD! Risk of severe injury or death. The Receiver causes ignition of the appliance, and the appliance can turn on suddenly. Stand away from the appliance burner when operating the remote system or activating manual bypass of the remote system.

! CAUTION

PROPERTY DAMAGE HAZARD.

The appliance can stay lit for many hours, creating excessive heat that can cause property damage. If the appliance will not be attended for any length of time, turn it OFF.

Never place the handheld remote control where children can reach it.

Remotely Turning ON the Appliance

Slide the wall switch to the REMOTE position, and then press the remote control ON/OFF key. A single "beep" from the receiver will confirm receipt of the command.

The remote control LCD screen will display icons for all active modes, and the burner will light.

Remotely Turning OFF the Appliance

Press the remote control ON/OFF key. The wall switch receiver will "beep" one time, the remote control LCD screen will display only the room temperature icon, and the burner will turn off.

Remote Control Key Lock Function

The Key Lock function disables the remote control keys to prevent unintended operation.

To activate or deactivate (toggle) the Key Lock function:

Press the MODE and UP ARROW keys at the same time.

Flame Control

The system has six flame levels (1–5 and MAX) (Figures 7 and 8).

To adjust the flame level:

With the system ON, repeatedly press MODE until the Flame icon displays.

Press the UP/DOWN ARROW key to increase/decrease the flame height.

Note: Pressing the UP ARROW key while the system is ON but the flame is OFF will cause the flame to turn on in the highest (MAX) position (Figure 8).

The wall switch receiver will beep each time the UP/DOWN ARROW key is pressed, to confirm receipt of the command.

Thermostat Operation

Use the remote control THERMOSTAT function to control the room temperature.

Repeatedly press the THERMOSTAT key to cycle the thermostat between ON, OFF, and SMART modes (Figure 6).

To change the temperature scale (°F to °C):

With the system in the OFF position, press the THERMOSTAT and MODE keys at the same time (see Figure 5, previous page).

To adjust the thermostat set temperature:

- Repeatedly press the THERMOSTAT key until “ON” displays next to the thermostat icon. The thermostat set temperature displays in the mode setting area of the LCD screen (Figure 6).
- Press the UP/DOWN ARROW key until the desired temperature displays.

To use SMART thermostat control:

- Repeatedly press the THERMOSTAT key until “SMART” displays next to the thermostat icon (Figure 6).
- The SMART thermostat function will automatically adjust the flame height (up or down) when the room temperature varies from the thermostat set temperature by more than 5 degrees.

Optional Blower Control

The optional Blower Kit (if installed) is operated with the remote control only (cannot be manually operated).

To operate the blower:

- Repeatedly press MODE until the BLOWER icon displays (Figure 6).
- Press the UP/DOWN ARROW key to adjust the blower speed through six levels (1–5 and OFF).
- See “IMPORTANT NOTES,” at right.

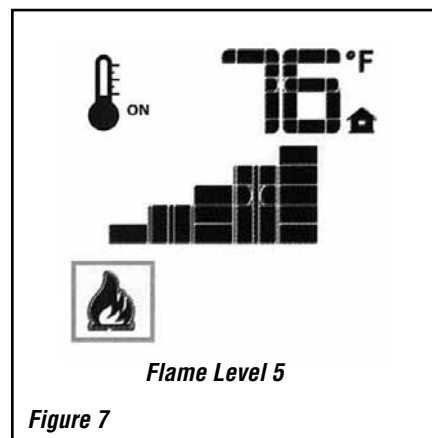
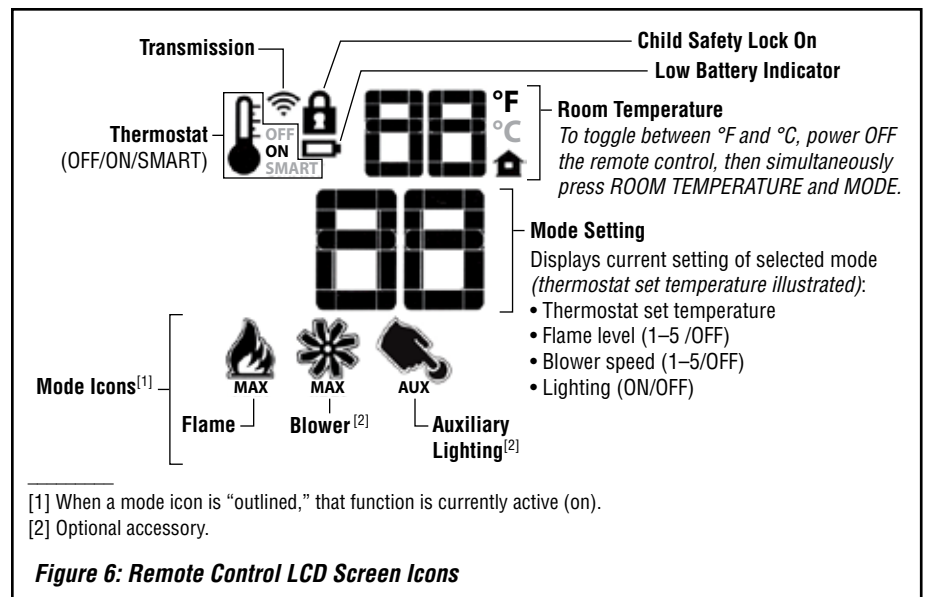

Optional Lighting Control

The optional Panel Backlighting Kit (if installed) is operated with the remote control only (cannot be manually operated).

To turn ON/OFF lighting:

- Repeatedly press MODE until the AUX icon displays (see Figure 6).
- Press the UP/DOWN ARROW key to toggle between “On” and “Off.”
- See “IMPORTANT NOTES,” at right.

Remote Control System Bypass (Flame operation only)

To manually turn ON the fireplace:

Slide the wall switch to the ON position. This will bypass all remote control, and the burner will light.

To manually turn OFF the fireplace:

- Slide the wall switch to the OFF position. The burner will shut off.
- See “IMPORTANT NOTES,” at right.

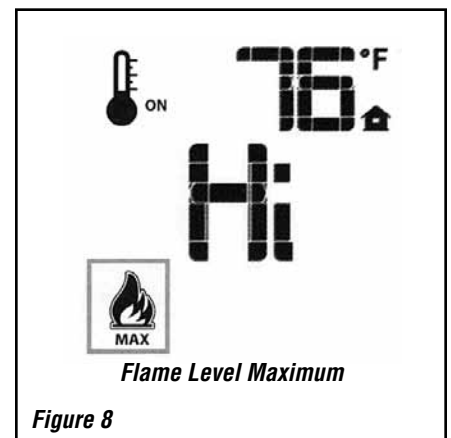

IMPORTANT NOTES

- When the batteries in the wall switch receiver or remote control are low or depleted, the fireplace can only be operated manually (ON/OFF).
- When bypassing the remote control system, the fireplace will operate at the last setting (Hi or Low) that was set by the remote control system.
- The optional blower and lighting functions can only be controlled using the remote control. Turning off the fireplace with the wall switch will NOT turn off the blower and/or lighting (if either option is installed). To turn off these functions, use the remote control **before** turning off the fireplace with the wall switch.

For additional setting information, refer to the instructions provided with the Remote Control Kit.

MAINTENANCE PROCEDURES

See maintenance schedule on *Page 18*.

Refer to the maintenance schedule for maintenance tasks, procedures, frequency and by whom they should be performed. Always verify proper operation of the appliance after servicing or maintenance.

WARNING

Turn off gas and electrical power to fireplace and allow it to cool before cleaning or servicing the appliance.

**HOT GLASS WILL CAUSE BURNS.
DO NOT TOUCH GLASS UNTIL COOLED.**

- Remove glass door assembly only when fireplace is OFF and COLD.
- Fireplace surfaces get EXTREMELY HOT!
- The glass on the front of the fireplace reaches EXTREMELY HIGH temperatures and can cause severe burns if touched. Even after the gas is turned off, fireplace surfaces remain extremely hot.

CAUTION: Wear gloves and safety glasses for protection while performing required maintenance.

Verify proper operation after servicing.

S'assurer que l'appareil fonctionne adéquatement une fois l'entretien terminé.

Always turn OFF gas to the pilot before cleaning.

Before relighting, refer to the lighting instructions in this manual. Lighting instructions are also provided on a tag attached to the fireplace door bracket.

Always keep the appliance area clear and free from combustible materials, gasoline and other flammable liquids.

Inspect Venting System (Qualified Service Technicians only)

The appliance and venting system should be thoroughly inspected before initial use and at least annually by a qualified service technician (inspection should include ensuring that exhaust or intake passages are unobstructed and vent components are properly assembled and not damaged). **Homeowner must contact a qualified service technician at once if any abnormal condition is observed.**

If the venting system is disassembled for any reason, a qualified service technician should follow vent installation instructions for proper reassembly and proper sealing of the venting system components. However, more frequent periodic inspections and cleanings should be performed by the homeowner.

Clean Door Glass, Liner Panels, Floor Kit, and Firebox

(For detailed instructions on removal and installation of the glass door, see *Page 13*.)

Note: Clean glass, liner panels, floor kit components, and fireplace interior after first two weeks of operation (after burn-in period is over) and then only when necessary and **ONLY WHEN THE APPLIANCE IS COOL**.

Wipe surface with clean, dampened, soft cloth. Follow with dry, soft towel, as desired. Take care not to scratch any surfaces.

WARNING: NEVER CLEAN GLASS OR FIREPLACE COMPONENTS WHEN HOT.

WARNING: Do NOT use abrasive cleaners.

Clean the glass and other interior surfaces two or three times during each heating season to remove any buildup caused by the following:

- *Filmy coating (during initial use after installation).* Initial curing of the high temperature paint and burning off of lubricants used in the manufacturing process may result in a filmy coating on the interior surface of the glass and other firebox components.
- *Dusty or dirty buildup.* It is normal for condensation and fog to form on the inside of the glass when first starting the appliance. This condensation and fog will usually disappear within a few minutes; however, over time the moisture can cause lint, dust, and other airborne particles to cling to the glass and other interior surfaces.
- *White coating.* A white coating may form on the glass and other interior surfaces as a result of impurities and minerals in the fuel.

Approved Glass Cleaning Solutions

The following cleaning solutions are approved for cleaning the glass, panels, floor kit components, and firebox interior:

- Ammonia-free household cleaner
- 50% white vinegar and 50% water
- Gas fireplace/stove glass cleaner

Inspect Glass Gasket

Visually inspect the gasket on the backside of the glass door. The gasket surface must be firmly seated, clean, and free of irregularities.

Clean Control Compartment (Qualified Service Technicians only)

Keep control compartment clean by vacuuming or brushing at least twice a year. More frequent cleaning may be required due to excessive lint from carpeting, bedding materials, etc. It is important that control compartments, burners and circulating air passageways of the appliance be kept clean.

Clean Burner

Before cleaning the burner, remove and clean media (if used) following the instructions below.

Carefully vacuum the burner to remove any foreign matter (e.g., lint, carbon). Make sure the burner ports are not clogged.

REMOVING AND CLEANING MEDIA

CAUTION: Risk of personal injury. Allow media to completely cool before handling.

To remove glass media from fireplace (for cleaning or replacement):

Use a clean, dry, empty shop vac.

1. Place media in colander or sieve, and carefully rinse under hot water.
2. Allow media to air dry before reinstalling.

Inspect Wiring

Refer to the wiring diagram in the fireplace *Installation Instructions*.

CAUTION: Label all wires prior to disconnection when servicing controls. Wiring errors can cause improper and dangerous operation. Verify proper operation after servicing.

ATTENTION: Au moment de l'entretien des commandes, étiquetez tous les fils avant de les débrancher. Des erreurs de câblage peuvent entraîner un fonctionnement inadéquat et dangereux.

Inspect and clean all wire connections. Make sure there is no melting or damage. Inspection should include:

- Terminals at the valve
- OFF/ON Switch

Inspect Burner Flame Appearance

Ensure that the burner flame appearance resembles the flame shown in *Figure 2 on Page 9* and as described in *Flame Appearance and Sooting on Page 9*.

IMPORTANT: If any abnormal condition is observed, turn OFF the fireplace and contact a qualified service technician.

Small Area Paint Touch-up

Only use a factory supplied paint kit for touch-ups. Paint is available at your local Lennox Hearth Products dealer. **Never attempt to paint a hot fireplace.**

INSTALLATION/REMOVAL OF GLASS DOOR ASSEMBLY AND MODESTY PANEL

⚠ WARNING

HOT GLASS WILL CAUSE BURNS. DO NOT TOUCH GLASS UNTIL COOLED.

- Remove glass door assembly only when fireplace is OFF and COLD.
- Do not attempt to touch the front enclosure glass with your hands while the fireplace is in use.
- The glass on the front of the fireplace reaches EXTREMELY HIGH temperatures and can cause severe burns if touched. Even after the gas is turned off, fireplace surfaces remain extremely hot.

⚠ WARNING

Any safety screen or guard removed for servicing the appliance must be replaced prior to operating the appliance.

⚠ AVERTISSEMENT

Tout écran ou protecteur retiré pour permettre l'entretien de l'appareil doit être remis en place avant de mettre l'appareil en marche.

⚠ WARNING

Do not operate appliance with glass front removed, cracked or broken.

⚠ AVERTISSEMENT

Ne pas utiliser l'appareil si le panneau frontal en verre n'est pas en place, est craqué ou brisé.

Note: When installing components, install the glass door assembly before installing the optional bezel. When removing components, remove the optional bezel before removing the glass door assembly.

Installation of Glass Door Assembly

1. While holding the door assembly by the side edges, hook the top edge to the fireplace, and then swing the bottom edge in toward the fireplace (*Figure 9*), taking care not to damage the glass.

⚠ IMPORTANT! If the lower flange of the door does NOT clear the lower front frame of the fireplace (and hits the frame as you swing down the door), make sure the door's UPPER mounting flange is completely and properly engaged on the

fireplace frame BEFORE INSERTING THE SCREWS.

Proper door alignment and sealing are important to the operation and performance of the fireplace. Make sure the door seal is in contact with the frame and that no air leaks are present.

2. Align the screw holes below the door assembly with the holes in the fireplace, and secure using the (3) provided screws.

Reverse these steps to remove the glass door assembly.

INSTALL MODESTY PANEL

NOTE: Modesty panel will not be used if surround and bezel will be installed.

To install the modesty panel, insert the four hooks on modesty panel into the four slots on door flange, then slide panel to the LEFT until fully seated (*see Figure 10*).

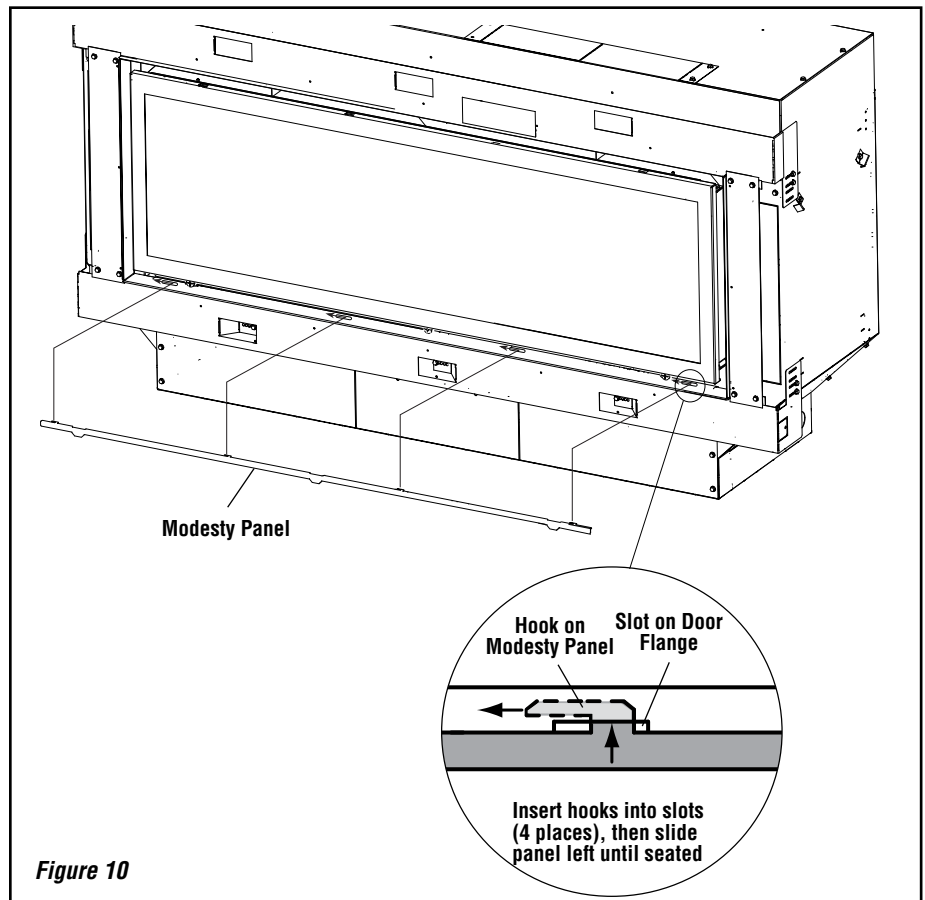
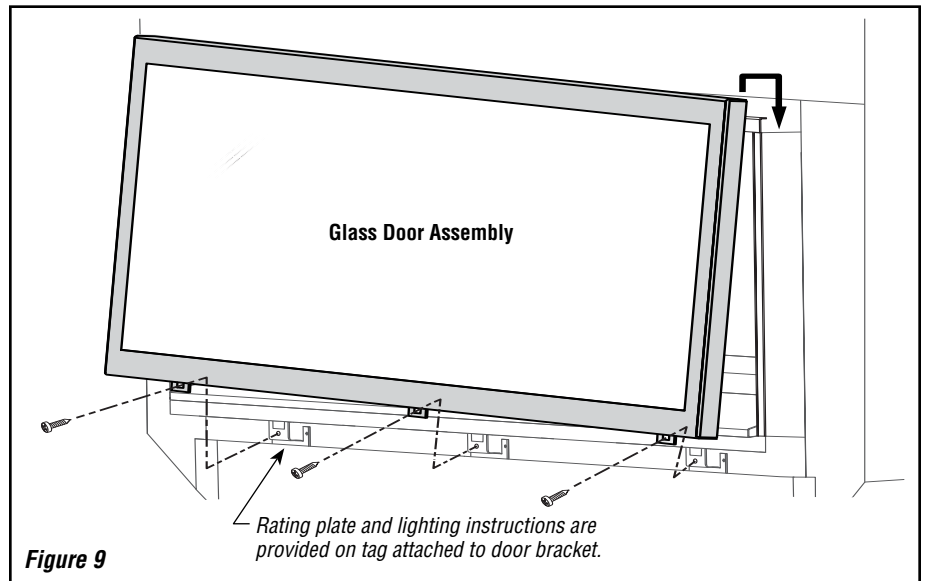

INSTALLATION/REMOVAL OF OPTIONAL BEZEL

1. Hook the **bezel upper flange** to the top edge of the **glass door frame**, and then swing the lower edge of the bezel toward the door (*Figure 11*).
2. Gently push the lower edge of the bezel to attach the **bezel lower flange** to the lower edge of the **glass door frame**.

Reverse these steps to remove the bezel.

⚠ CAUTION

RISK OF PERSONAL INJURY OR PROPERTY DAMAGE.

- **Do NOT abuse glass door by striking or slamming shut.**
- **Handle glass with extreme care! Glass is susceptible to damage; do NOT scratch or handle roughly while reinstalling the glass door frame.**
- **Never operate fireplace with glass door assembly removed.**

These direct-vent appliances are designed to operate only when glass door assembly is installed. Generally, the glass door assembly should not be removed, except when access to components within the firebox is required.

- **Do not attempt to substitute the materials used on these doors, or replace cracked or broken glass.**
- **The glass door(s) of this appliance must only be replaced as a complete unit as provided by the manufacturer. Do not attempt to replace broken, cracked or chipped glass separately.**

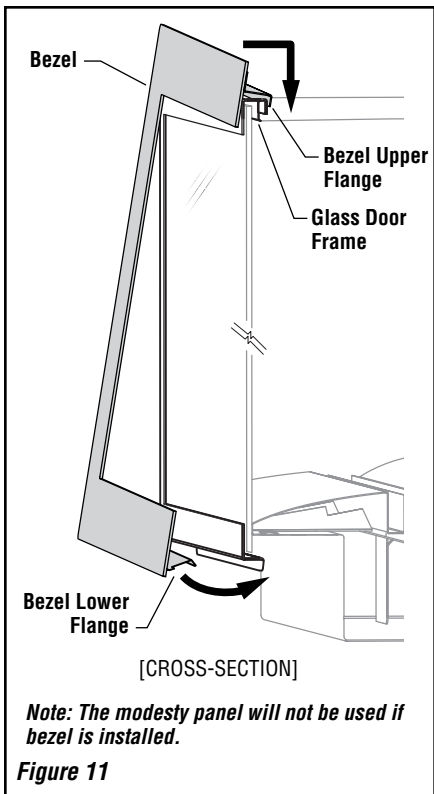

LIGHTING INSTRUCTIONS

FOR YOUR SAFETY READ BEFORE OPERATING

WARNING: If you do not follow these instructions exactly, a fire or explosion may result causing property damage, personal injury or loss of life.

- A. This appliance is equipped with an ignition device which automatically lights the pilot. Do not try to light the pilot by hand.
- B. BEFORE OPERATING smell all around the appliance area for gas. Be sure to smell next to the floor because some gas is heavier than air and will settle on the floor.
- WHAT TO DO IF YOU SMELL GAS:
 - Do not try to light any appliance.
 - Do not touch any electric switch; do not use any phone in your building.
- Immediately call your gas supplier from a neighbor's phone. Follow the gas supplier's instructions.
- If you cannot reach your gas supplier, call the fire department.
- C. If any portion of this appliance does not operate as the instructions indicate, do not try to repair it; instead, call a qualified service technician. Do not use tools. Force or attempted repair may result in a fire or explosion.
- D. Do not use this appliance if any part has been under water. Immediately call a qualified service technician to inspect the appliance and to replace any part of the control system and any gas control which has been under water.

OPERATING INSTRUCTIONS

1. STOP! Read the safety information above on this label.
2. Read the Care and Operation manual including the section on "Remote Control System."
3. Slide the switch on the receiver to "OFF."
4. Press ON/OFF button on remote control transmitter to "OFF."
5. Turn "OFF" all electric power to the appliance.
6. This appliance is equipped with an ignition device which automatically lights the pilot. Do not try to light the pilot by hand.
7. Wait five (5) minutes to clear out any gas. If you then smell gas, STOP! Follow "B" in the safety information above on this page. If you do not smell gas, go to the next step.
8. Turn on all electric power to the appliance.
9. Slide the switch on the receiver to REMOTE.
10. Press ON/OFF button on remote control transmitter to "ON."
11. Set thermostat on remote control to desired setting.
12. If the appliance will not operate, follow the instructions "To Turn Off Gas To Appliance" and call your service technician or gas supplier.

Electronic Gas Control Valve - SIT Proflame



Electronic Pilot Assembly

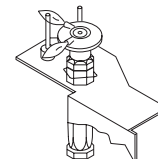

Receiver

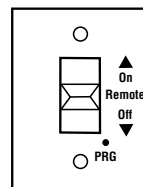

Remote Control Transmitter



TO TURN OFF GAS TO APPLIANCE

1. Slide the switch on the receiver to "OFF."
2. Press ON/OFF button on remote control transmitter to "OFF."
3. Turn off all electric power to the appliance if service is to be performed.
4. Close the main line gas shut-off valve.



WARNING



**HOT GLASS WILL CAUSE BURNS.
DO NOT TOUCH GLASS UNTIL COOLED.
NEVER ALLOW CHILDREN TO TOUCH GLASS.**

INSTRUCTIONS D'ALLUMAGE

POUR PLUS DE SÉCURITÉ LIRE AVANT DE METTRE EN MARCHÉ

AVERTISSEMENT. Quiconque ne respecte pas à la lettre les instructions dans la présente notice risque de déclencher un incendie ou une explosion entraînant des dommages, des blessures ou la mort.

A. Cet appareil est muni d'un dispositif d'allumage qui allume automatiquement la veilleuse. Ne tentez pas d'allumer la veilleuse manuellement.

B. AVANT DE FAIRE FONCTIONNER, reniflez tout autour de l'appareil pour déceler une odeur de gaz. Reniflez près du plancher, car certains gaz sont plus lourds que l'air et peuvent s'accumuler au niveau du sol.

QUE FAIRE SI VOUS SENTEZ UNE ODEUR DE GAZ :

- Ne pas tenter d'allumer d'appareil.
- Ne touchez à aucun interrupteur; ne pas vous servir des téléphones se trouvant dans le bâtiment.

• Appelez immédiatement votre fournisseur de gaz depuis un voisin. Suivez les instructions du fournisseur.

• Si vous ne pouvez rejoindre le fournisseur, appelez le service des incendies.

C. Si un élément de cette unité ne fonctionne pas tel que décrit dans les instructions, n'essayez pas de le réparer, appelez un technicien qualifié. N'utilisez pas d'outils. Le fait de forcer la manette ou de la réparer peut déclencher une explosion ou un incendie.

D. N'utilisez pas cet appareil s'il a été plongé dans l'eau, même partiellement. Faites inspecter l'appareil par un technicien qualifié et remplacez toute partie du système de contrôle et toute commande qui ont été plongés dans l'eau.

INSTRUCTIONS DE MISE EN MARCHÉ

1. ARRÊTEZ ! Lisez les avertissements de sécurité à l'endos de cette étiquette.
2. Lisez le manuel d'utilisation et d'entretien incluant la section « Système de télécommande ».
3. Placez l'interrupteur du récepteur en position « OFF ».
4. Appuyez sur le bouton « ON/OFF » pour sélectionner « OFF ».
5. Coupez l'alimentation électrique de l'appareil.
6. Cet appareil est muni d'un dispositif d'allumage qui allume automatiquement la veilleuse. Ne tentez pas d'allumer la veilleuse manuellement.
7. Attendre cinq (5) minutes** pour laisser échapper tout le gaz. Reniflez tout autour de l'appareil, y compris près du plancher, pour déceler une odeur de gaz. Si vous sentez une odeur de gaz, ARRÊTEZ ! Passez à l'étape B des instructions de sécurité sur la portion supérieure (à gauche) de cette étiquette. S'il n'y a pas d'odeur de gaz, passez à l'étape suivante.
8. Mettez l'appareil sous tension.
9. Placez l'interrupteur du récepteur en position « REMOTE ».
10. Appuyez sur le bouton « ON/OFF » pour sélectionner « ON ».
11. Ajustez le thermostat sur la télécommande à l'ajustement désiré.
12. Si l'appareil ne se met pas en marche, suivez les instructions intitulées « Comment couper l'admission de gaz de l'appareil » et appelez un technicien qualifié ou le fournisseur de gaz.

Valve électronique - SIT Proflame



Module de veilleuse électronique

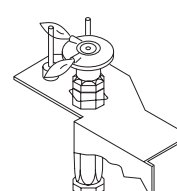

Récepteur

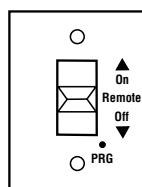

Télécommande



COMMENT COUPER L'ADMISSION DE GAZ DE L'APPAREIL

1. Coupez l'alimentation électrique de l'appareil s'il faut procéder à l'entretien.
2. Sélectionnez OFF sur le récepteur.
3. Appuyez sur le bouton ON/OFF et sélectionnez OFF.
4. Fermer la valve de gaz principale.



AVERTISSEMENT



**UNE SURFACE VITRÉE CHAUDE PEUT CAUSER DES BRÛLURES.
LAISSER REFROIDIR LA SURFACE VITRÉE AVANT D'Y TOUCHER.
NE PERMETTEZ JAMAIS À UN ENFANT DE TOUCHER LA SURFACE VITRÉE.**

MAINTENANCE SCHEDULE

Annually (before onset of burning season)

Maintenance Task	Accomplishing Person	Procedure
Inspect/Clean Burner, Panels, and Controls	Qualified Service Technician	Inspect valve and ensure it is properly operating. Check piping for leaks. Vacuum the control compartment and burner area.
Check Flame Patterns and Flame Height	Qualified Service Technician	Verify that the flame pattern and height are similar to Figure 2 . Flames must not touch the panels or fireplace ceiling.
Inspect/Clean Pilot and Burner	Qualified Service Technician	Remove any surface buildup on pilot and burner assembly. Wipe the pilot nozzles, ignitor/flame rod, and hood. Make sure the pilot flame engulfs the flame sensor as shown.
Check Vent System	Qualified Service Technician	Remove baffle. Inspect vent system at the termination and at the base (within the fire-box) for signs of blockage or obstruction. Look for any signs of dislocation of the vent components.
Appliance Checkout	Qualified Service Technician	Perform the appropriate appliance checkout procedure detailed in this manual.

Periodically (after burning season)

Maintenance Task	Accomplishing Person	Procedure
Clean Fireplace Interior	Homeowner	Carefully remove media (if applicable), following instructions on Page 12 . Vacuum out fireplace interior. Clean panels as detailed in the MAINTENANCE section of this manual. Clean and replace media as detailed on Page 12 .
Check Flame Patterns and Flame Height	Homeowner	Verify that the flame pattern and height are similar to Figure 2 . Flames must not touch the panels or fireplace ceiling.
Clean Front Glass Enclosure Panel	Homeowner	Clean glass as detailed in the MAINTENANCE section of this manual. IMPORTANT! ALLOW GLASS TO COMPLETELY COOL BEFORE CLEANING. NEVER TOUCH OR TRY TO CLEAN HOT GLASS.

TROUBLESHOOTING GUIDE

Important: Valve system troubleshooting should only be performed by a qualified service technician.

Note: Before troubleshooting the gas control system, make sure the external gas shutoff valve (located at gas supply inlet) is in the “ON” position.

SYMPTOM	POSSIBLE CAUSES	CORRECTIVE ACTION
1. Nothing happens when the fireplace is turned ON/OFF.	A. Remote control system is not functioning properly.	To use the remote control system, the wall switch plate must be set to REMOTE.
		Manually operate the fireplace using the wall switch (ON/OFF).
		Replace the batteries in the handheld remote and/or behind the wall switchplate.
	B. Unit is not receiving power.	Check/replace batteries behind the wall switchplate.
		Check building circuit breakers to ensure power is on to the fireplace.
C. Gas is not reaching the fireplace.	Check the gas supply and gas shutoff valves (call a service technician, if required).*	
2. The main burner does not light and the igniter is sparking.	A. Gas is not reaching the fireplace.	Check the gas supply and gas shutoff valves (call a service technician, if required).*
	B. Loose wires to the valve.	Check control compartment for any obvious loose wiring (call a service technician).
	C. Loose wires to ignition module.	Check control compartment for any obvious loose wiring (call a service technician).
	D. Air in the gas line.	Purge gas line of air (call a service technician).
3. The burner lights, then immediately goes out.	A. Gas is not reaching the fireplace.	Check the gas supply and gas shutoff valves (call a service technician, if required).*
	B. Loose wires to the valve or ignition module.	Check the gas supply and gas shutoff valves (call a service technician, if required).*
	C. Pilot flame is not engulfing the sensor.	Call a service technician.
	D. Obstructed vent system.	Call a service technician.
4. Soot is present on the glass and panels.	A. Initial fireplace operation.	A white film may develop on the glass during the first few fires as part of the burn-in process. The first few times you use the fireplace, clean the glass after each use (AFTER THE GLASS HAS COMPLETELY COOLED); otherwise, the white film will bake onto the glass and become difficult to remove. See glass cleaning instructions in the MAINTENANCE section of this manual.
	B. Excessive flame impingement on panels and fireplace ceiling.	Properly position the media as detailed in the instructions on Page 26 of the Installation Instructions manual.
	C. Improper air shutter opening.	Open the air shutter by adjusting the air shutter adjustment lever according to the instructions in this manual.
	D. Improper vent restrictor setting.	Open the air shutter by adjusting the air shutter adjustment lever according to the instructions in this manual.
5. Poor flame and/or blue flame.	Door seal is not properly aligned, causing gaps and air leaks.	Remove and realign the door so the gasket seal is fully engaged around the door frame.

*The unit may have multiple gas supply shutoffs (the main gas supply valve in the house, the gas supply valve in the fireplace control compartment, and/or an additional shutoff valve near the fireplace).

REQUIRED ACCESSORIES

REQUIRED: PANEL KIT		
Description	Cat. No.	Model No.
PANEL KIT OPTIONS		
42" Panel Kit - Illusion [Ⓛ] Cityscape - Black Porcelain	H8832	IPK-CBLKP-RAP42
42" Panel Kit - Illusion [Ⓛ] Metroscope - Black Porcelain	H8833	IPK-MBLKP-RAP42
54" Panel Kit - Illusion [Ⓛ] Cityscape - Black Porcelain	H8420	IPK-CBLKP-RAP54
54" Panel Kit - Illusion [Ⓛ] Metroscope - Black Porcelain	H8421	IPK-MBLKP-RAP54
42" Panel Kit - Naked - Black Porcelain	H8834	NPK-BLP-RAP42
42" Panel Kit - Naked - Black Satin Paint	H8835	NPK-BLS-RAP42
54" Panel Kit - Naked - Black Porcelain	H8422	NPK-BLP-RAP54
54" Panel Kit - Naked - Black Satin Paint	H8423	NPK-BLS-RAP54

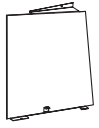

Left Side Panel

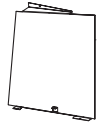

Right Side Panel



Illusion Cityscape Back Panel

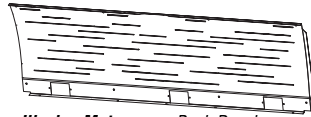

Illusion Metroscope Back Panel

Ⓛ "Illusion" style Panel Kits are designed for use with a **Panel Backlighting Kit** (listed under OPTIONAL: PANEL BACKLIGHTING KIT).

REQUIRED: FLOOR KIT		
Description	Cat. No.	Model No.
REFLECTION FLOOR KIT OPTIONS (does not use media)		
42" Floor Kit - Reflection - Black Porcelain	H8836	RFK-BLP-RAP42
54" Floor Kit - Reflection - Black Porcelain	H8425	RFK-BLP-RAP54
DESIGNER FLOOR KIT OPTIONS (requires one Media Kit)		
42" Floor Kit - Designer [Ⓢ] - Black Porcelain	H8838	DFK-BLP-RAP42
42" Floor Kit - Designer [Ⓢ] - Black Satin	H8837	DFK-BLS-RAP42
54" Floor Kit - Designer [Ⓢ] - Black Porcelain	H8427	DFK-BLP-RAP54
54" Floor Kit - Designer [Ⓢ] - Black Satin	H8426	DFK-BLS-RAP54
MEDIA KIT OPTIONS (one kit required with DESIGNER style Floor Kits only) [Also see Media Kit Instruction Sheet P/N 506019-86]		
Glass Media 5-lb bag - Reflective Black	H8412	CRSHGL-RBLK
Glass Media 5-lb bag - Reflective Blue	H8424	CRSHGL-RBLU
Glass Media 5-lb bag - Platinum	H8413	CRSHGL-P
Glass Media 5-lb bag - Goldfinger	H8538	CRSHGL-GF
Glass Media 5-lb bag - Copper	H8539	CRSHGL-C

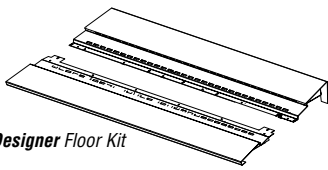

Designer Floor Kit



Glass Media

For additional information, visit
www.LennoxHearthProducts.com
 (>Owner Resources >Product Literature)

OPTIONAL ACCESSORIES

OPTIONAL: PANEL BACKLIGHTING KIT[Ⓢ]		
Description	Cat. No.	Model No.
Panel Backlighting Kit, RAP42	H8866	IPBLK-RAP42
Panel Backlighting Kit, RAP54	H8429	IPBLK-RAP54

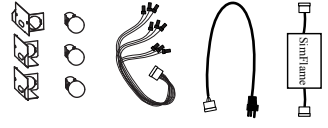
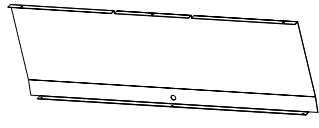

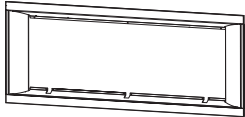

Ⓢ Panel Backlighting Kit is designed for use with "Illusion" style Panel Kits (listed under REQUIRED: PANEL KIT).

OPTIONAL: SURROUND KIT AND BEZEL KIT[Ⓢ]		
Description	Cat. No.	Model No.
SURROUND KIT OPTIONS		
42" Surround - Black Satin	H8825	CS-BLS-RAP42
42" Surround - Carbon Fiber	H8826	CS-CF-RAP42
42" Surround - Wood Grain	H8827	CS-WG-RAP42
54" Surround Kit - Black Satin	H8414	CS-BLS-RAP54
54" Surround Kit - Carbon Fiber	H8415	CS-CF-RAP54
54" Surround Kit - Wood Grain	H8416	CS-WG-RAP54
BEZEL KIT OPTIONS		
42" Bezel - Brushed Nickel	H8829	BZL-BRNI-RAP42
42" Bezel - Black Nickel	H8830	BZL-BLNI-RAP42
42" Bezel - Black Satin	H8831	BZL-BLS-RAP42
54" Bezel Kit - Black Satin	H8419	BZL-BLS-RAP54
54" Bezel Kit - Black Nickel	H8418	BZL-BLNI-RAP54
54" Bezel Kit - Brushed Nickel	H8417	BZL-BRNI-RAP54

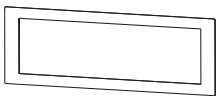

Surround



Bezel

Ⓢ Surround and Bezel should be used together for a finished appearance.

OTHER OPTIONAL ACCESSORIES		
Description	Cat. No.	Model No.
Blower Kit - FBK-100 (manual P/N 750028M)	80L84	FBK-100
Power Vent Kit (manual P/N 506022-01)	H7387	LPVK-110
Power Vent Adaptor Kit 54-42 (manual P/N 506019-82)	H8574	PVK-RHAP
Gas Conversion Kit 54-42, NG to LP (manual P/N 506019-90)	H8540	GCK-RHAP-NP

CATNOREQ-011912

REPLACEMENT PARTS

Ordering Replacement Parts

Consumer-orderable replacement parts are listed on *this page*. (All accessories listed on the *previous page* are also consumer-orderable.) **Use only parts supplied from the manufacturer.**

With proper care and maintenance, your appliance will provide many years of enjoyment. If you experience any problem, first refer to the troubleshooting guide in this manual. If the problem persists or you have any questions about your fireplace system, contact your Lennox Hearth Products dealer or distributor.

Order parts through your Lennox Hearth Products dealer or distributor. Parts will be shipped at prevailing prices at time of order.

When ordering parts, please provide the following information:

1. Appliance model number.
2. Appliance serial number.
3. Part number.
4. Part description.
5. Quantity required.
6. Appliance installation date.

WARNING

Failure to position the parts in accordance with these diagrams or failure to use only parts specifically approved with this appliance may result in property damage or personal injury.

AVERTISSEMENT

Risque de dommages ou de blessures si les pièces ne sont pas installées conformément à ces schémas et ou si des pièces autres que celles spécifiquement approuvées avec cet appareil sont utilisées.

Replacement Parts List

Contact an Lennox Hearth Products dealer to obtain any of these parts. Never use substitute materials. Use of non-approved parts can result in poor performance and safety hazards and may void the warranty.

Item No.	Catalog No.	Description	Qty.
1	H8799	Door Assembly, RAP42 (Fireplace Glass Enclosure)	1
1	H8431	Door Assembly, RAP54 (Fireplace Glass Enclosure)	1
2	H8787	Top Baffle, RAP42	1
2	H8583	Top Baffle, RAP54	1
3	80L84	Blower Assembly FBK-100	1
4	H8439	SimFlame (light flicker) - module only	1
5	H8438	Light Bulb	1

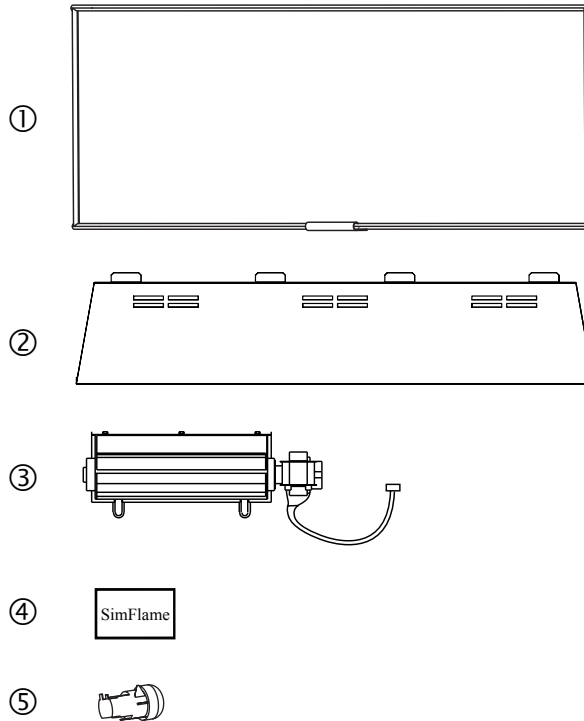

PRODUCT REFERENCE INFORMATION

We recommend that you record the important reference information about your fireplace in the space provided below.

Please call Lennox Hearth Products for the phone number of your nearest LHP dealer, who will answer your questions or address your concerns.

LENNOX HEARTH PRODUCTS
 1508 Elm Hill Pike, Suite 108
 Nashville, TN 37210
 Visit us at www.LennoxHearthProducts.com
 1-800-655-2008

Product Information	
Fireplace Model	Cat. No.
RHAP42N	H8612
RHAP54N	H8410

PRODUCT REFERENCE INFORMATION

Model Number _____
 Serial Number _____
 Date Installed _____
 Gas Type Used _____
 Dealer Name _____

NOTES

Lennox Hearth Products reserves the right to make changes at any time, without notice, in design, materials, specifications, and prices, and also to discontinue colors, styles, and products. Consult your local distributor for fireplace code information.

LENNOX®, the LENNOX design, DAVE LENNOX, the image of DAVE LENNOX and other related LENNOX marks are registered or common law trademarks of Lennox Industries Inc. and are used with permission.

