



An innovative contemporary fireplace delivers sophisticated appeal with Infini-Flame™ technology and a variety of stunning design options.

DAVE LENNOX
signature
COLLECTION



LENNOX
HEARTH PRODUCTS



Rhapsody™ shown with Clean Face finish, Nike Black Porcelain back panel and Reflection floor.

■ Linear in design and stunningly multifaceted in effect, Rhapsody expands the appeal of the Dave Lennox *Signature®* Collection, offering a sophisticated, energy-efficient and easy-to-install heating option for modern homes. Its 51 and 39 inch-wide viewing area showcases a continuous band of wavering flames that's enhanced by a porcelain interior with illusion panels and backlighting. A choice of finishes adds to the beauty of the fireplace and its long, mesmerizing flicker of flames. ■

CUSTOMIZE TO YOUR TASTE

The Dave Lennox *Signature*® Collection Rhapsody™ Direct-Vent Gas Fireplace gives you a variety of options to create a custom appearance that will complement the style of your home. Simply start by choosing a firebox floor and back panel kit, then add an optional surround finish for a fireplace that's uniquely yours. You can also customize the Rhapsody with our Design A Fireplace tool online at lennox.com. Rest assured, with so many stunning options, it's impossible to make a wrong choice.

STEP 1: FIREBOX FLOOR (required design option)

Choose from two modern floors to customize your fireplace.



Reflection floor has curved porcelain design that enhances the flame.



Designer (requires glass media selection below)



Reflective Black

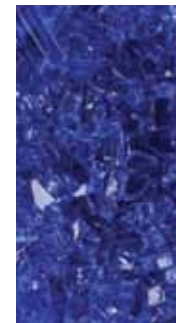

Reflective Blue



Platinum

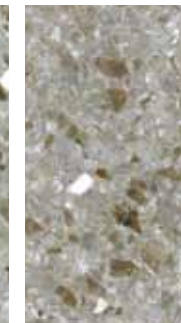

Goldfinger

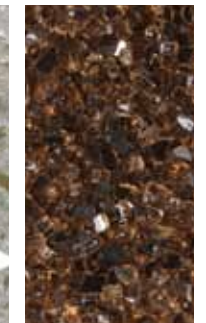

Copper

STEP 2: PANEL KIT (required design option)

Select from four curved back panel kits to add a unique backdrop to your fire.

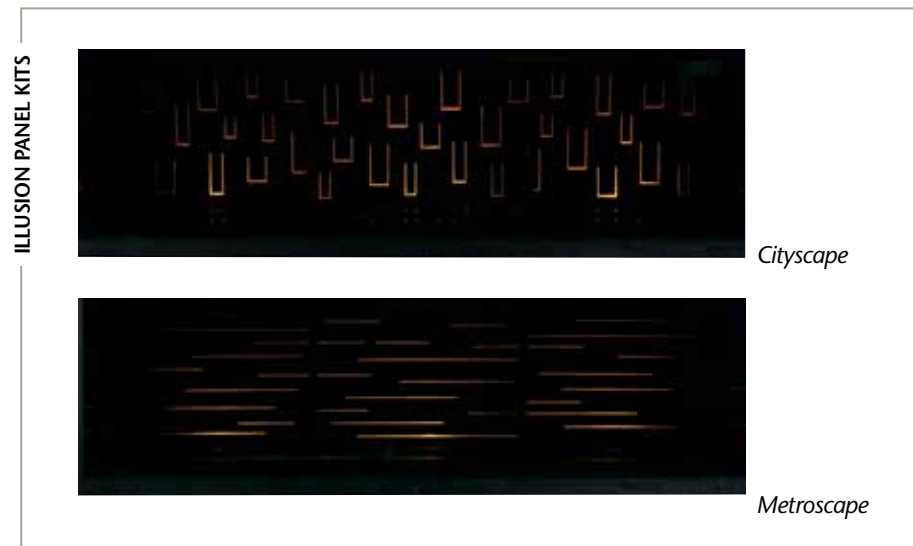

STEP 3: SURROUND & BEZEL (optional – requires bezel selection)

Add an optional surround and bezel to frame the view of the fire and to finish the exterior of your fireplace.

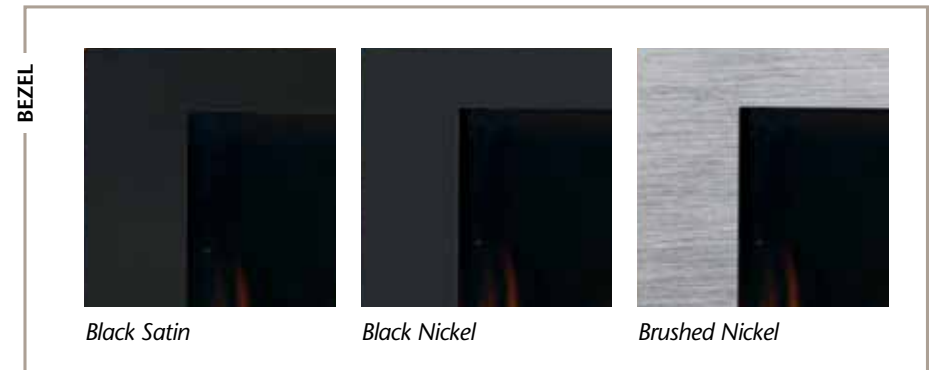
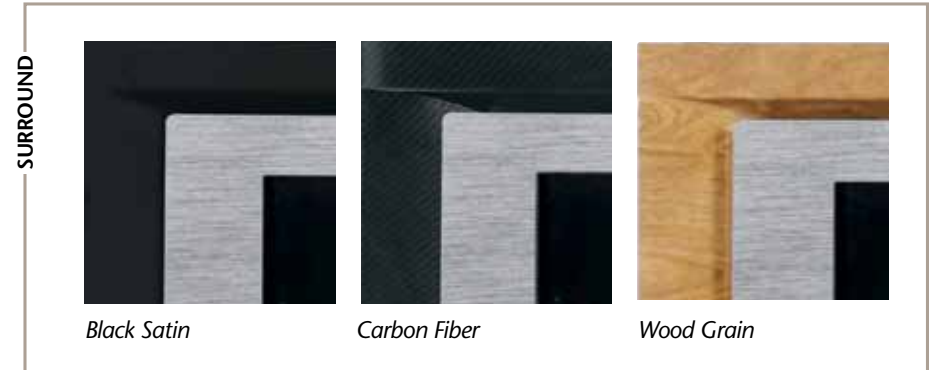



Rhapsody™ 54 shown with Carbon Fiber surround, Brushed Nickel bezel and Platinum media.



Rhapsody™ 42 shown with Satin Black surround, Brushed Nickel bezel and Copper media.



Designer floor: With a choice from five colored-glass media options to add sparkle and complement your room's décor.

STANDARD FEATURES

Expansive viewing area creates a breathtaking linear design to complement any home.

Innovative Infini-Flame™ technology produces a continuous band of tranquil flames across the viewing area.

Back panels in Black Satin or Reflective Porcelain provide a stunning backdrop to the fire.

Recessed surround available in all designer finishes.

Backlighting Kit is available to enhance the optional Illusion Panel with added design interest even when the fireplace is not in use.

Patent-Pending burner design with industry-leading energy efficiency delivers outstanding flame height and more visible flame per BTU.

Lennox Total Comfort Control™ system features remote temperature control and uninterrupted operation in the event of a power failure.

RHAPSODY DIMENSIONS

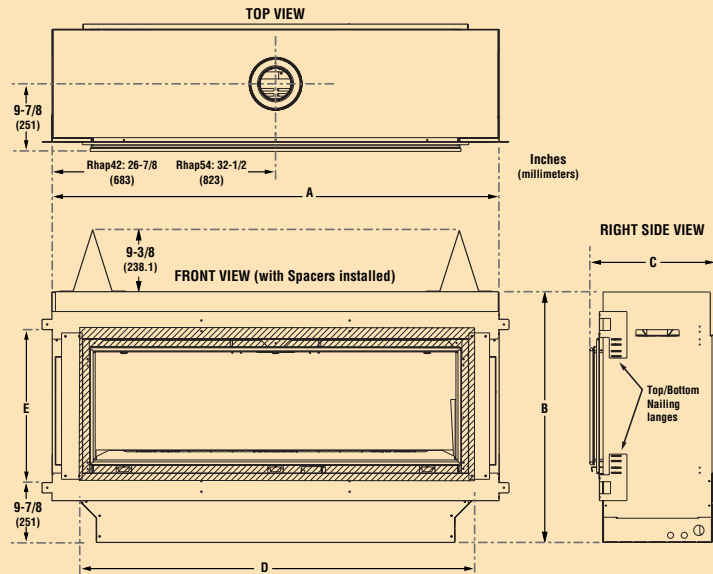

Efficiency % RHAP42N

	NATURAL GAS	PROPANE
EnerGuide	61%	66%
AFUE*	67%	68.5%

Efficiency % RHAP54N

	NATURAL GAS	PROPANE
EnerGuide	66.9%	71.8%
AFUE*	70.2%	69.8%

*Annual Fuel Utilization Efficiency (AFUE) is the recognized U.S. rating system for the total efficiency of heating products.

Specifications

Model	FRAMING					BTU INPUT RATE	
	Width (A)	Height (B)	Depth (C)	Width (D)	Height (E)	Natural Gas	Propane
RHAP42N	53-3/4"	42"	18-1/2"	44"	15 3/4"	27,000 high	25,000 high
	1366 mm	1067 mm	470 mm	1118 mm	400 mm	19,500 low	19,500 low
RHAP54N	65-3/4"	46-3/4"	18-1/2"	56"	19 3/4"	37,000 high	34,000 high
	1670 mm	1184 mm	470 mm	1422 mm	502 mm	27,000 low	27,000 low

These appliances comply with National Safety Standards and are tested and listed by Intertek (Report No. 100404899PRT-001) to ANSI Z21.88 (in Canada, CSA-2.33), and CAN/CGA-2.17M91 (CSA P4.1) in both U.S.A. and Canada, as vented gas fireplace heaters.

Rhapsody Linear (Model RHAP42N)

Viewable Glass Size	39" Wide; 10-3/4" High
Vent Collar Size	4-1/2" Inner; 7-1/2" Outer
Surround Dims.	55" Wide; 22-1/4" High

Rhapsody Linear (Model RHAP54N)

Viewable Glass Size	51" Wide; 14-3/4" High
Vent Collar Size	4-1/2" Inner; 7-1/2" Outer
Surround Dims.	67" Wide; 26" High

PRODUCTS AND DEALERS YOU CAN COUNT ON

At Lennox, we understand how important it is for you to feel comfortable at home, so we're committed to providing you with the finest hearth products available. Choosing the right dealer for your hearth needs is every bit as important as choosing the right brand, and we think you'll agree that our dealers are a big reason why you can count on getting quality customer service when you call.



HEARTH PRODUCTS

© Lennox Hearth Products LLC 2012

Visit us at www.lennoxhearthproducts.com

or contact us at 1-800-655-2008

785326M 10/12

All Dave Lennox Signature® Collection gas fireplaces utilize either a Secure Vent™ (rigid) or Secure Flex™ (flexible) 4.5" inner/7.5" outer coaxial venting system and include a limited lifetime warranty.

IMPORTANT NOTES:

As with any heating appliance, fireplace or stove, this appliance is extremely hot during operation. Read and understand all operating instructions before using this appliance. For further information, consult your dealer.

Local conditions, such as elevation, wind, vent configuration and choice of fuel will affect overall appearance of the fire and heating performance. Performance can also vary with home design and insulation, climate, condition and type of fuel used, appliance location, burn rate, accessories chosen, chimney installation and how the appliance is operated.

Diagrams, illustrations and photographs are not to scale—consult installation instructions. Product designs, materials, dimensions, specifications, colors and prices are subject to change or discontinuation without notice.

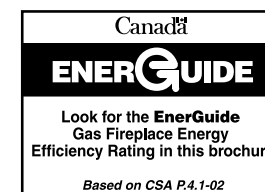

100% recycled

Intertek
Report #100404899PRT-001