



Tribute DV

(Model 8050)

GAS-FIRED DIRECT-VENT HEATER









**Owner's Manual
& Installation Guide**



READ THIS OWNER'S MANUAL

Operate And Maintain This Gas Heater According To This Instruction Manual.

Save These Instructions!

<p>WARNING: IF THE INFORMATION IN THESE INSTRUCTIONS IS NOT FOLLOWED EXACTLY, A FIRE OR EXPLOSION CAN RESULT CAUSING PROPERTY DAMAGE, PERSONAL INJURY OR LOSS OF LIFE.</p> <p>Do not store or use gasoline or other flammable vapors and liquids near this or any other gas appliance.</p> <p>WHAT TO DO IF YOU SMELL GAS:</p> <ul style="list-style-type: none">  Do not try to light any appliance.  Do not touch electrical switches; do not use the phone in your building.  Immediately call your gas supplier from a neighbor's phone. Follow your gas supplier's instructions.  If you cannot reach your gas supplier, call the fire department. <p>A qualified installer, service agency or gas supplier must perform installation and service. The Commonwealth of Massachusetts requires that a licensed gas fitter or licensed plumber install all gas lines and gas fittings.</p>	<p>AVERTISSEMENT: ASSUREZ-VOUS DE BIEN SUIVRE LES INSTRUCTIONS DONNÉ DANS CETTE NOTICE POUR RÉDUIRE AU MINIMUM LE RISQUE D'INCENDIE OU POUR ÉVITER TOUT DOMMAGE MATÉRIEL, TOUTE BLESSURE OU LA MORT.</p> <p><i>Ne pas entresposer ni utiliser d'essence ni d'autre vaperurs ou liquides inflammables dans le voisinage de cet appareil ou de tout autre appareil.</i></p> <p>QUE FAIRE SI VOUS SENTEZ UNE ODEUR DE GAZ:</p> <ul style="list-style-type: none">  <i>Ne pas tenter d'allumer d'appareil.</i>  <i>Ne touchez à aucun interrupteur. Ne pas vous servir des téléphones se trouvant dans le batiment où vous vous trouvez.</i>  <i>Appelez immédiatement votre fournisseur de gaz depuis un voisin. Suivez les instructions du fournisseur.</i>  <i>Si vous ne pouvez rejoindre le fournisseur de gaz, appelez le service des incendies.</i> <p><i>L'installation et service doit être exécuté par un installateur qualifié, agence de service ou le fournisseur de gaz.</i></p>
---	--

Intentionally Blank

Table of Contents

INTRODUCTION	5
SPECIFIED VENTING MANUFACTURER CONTACT INFORMATION	6
SPECIFICATIONS	7
OWNER’S INFORMATION	8
DAILY OPERATION	8
EFFICIENCY.....	8
INSTALLER’S INFORMATION	9
CODES	9
ITEMS REQUIRED FOR INSTALLATION	9
PACKING LIST	9
UNPACKING AND INSPECTION	9
INSTALLING THE TRIBUTE DV	10
HEARTH REQUIREMENT/FLOOR PROTECTION	10
CLEARANCE TO COMBUSTIBLES	10
ACCEPTABLE DIRECT-VENT TERMINATION CAP LOCATIONS.....	11
VENTING INFORMATION	12
VENTING COMPONENTS & CONFIGURATION	12
APPROVED VENTING SYSTEM COMPONENTS	14
ELECTRICAL CONNECTIONS	16
WIRING INSTRUCTIONS	17
GAS SUPPLY & CONNECTIONS	18
LOG PLACEMENT	20
INSTALLATION OF THE LOG SET.....	20
REMOVAL OF LOG SET.....	21
STONE INSTALLATION	22
LIGHTING THE UNIT FOR THE FIRST TIME	23
INITIAL ADJUSTMENTS	24
LIGHTING INSTRUCTIONS	24
AIR SHUTTER ADJUSTMENTS	25
PILOT ADJUSTMENT.....	25
ROUTINE MAINTENANCE AND CARE	27
CLEANING THE UNIT	27
GLASS CLEANING	28
VENTING	28
PARTS LIST	29
TROUBLESHOOTING	30
RATING LABEL	33

INTRODUCTION

Congratulations on your purchase of Hearthstone's Tribute DV Model 8050 Gas-Fired Direct Vent heater. The Tribute DV incorporates the latest in balanced vent gas technology, which will provide you with clean, efficient heat for years to come. Combustion air comes directly from the outside of your home to the sealed firebox system, eliminating the potential for annoying back drafts or other problems associated with home depressurization.

The Tribute DV will provide you with years of practical and convenient service. However, as with any gas appliance, the unit must be properly and safely installed and maintained by qualified service personnel to ensure safe and trouble-free operation. It includes the new TEK Fire log technology, which is an amazing blend of realistic flames and glowing embers with incredible heating characteristics.

Read this Owner's Manual

Operate and maintain this gas heater according to the instructions in this manual. For your safety, and years of trouble free operation, read this manual in its entirety. By following a few simple safety precautions and by performing minimal maintenance, the unit will remain appealing while providing years of quality performance.

 **WARNING! USE ONLY A QUALIFIED SERVICE TECHNICIAN TO DO THE INSTALLATION, AND REPAIR. A QUALIFIED SERVICE TECHNICIAN MUST INSPECT THE APPLIANCE BEFORE USE, AND AT LEAST ANNUALLY. MORE FREQUENT CLEANING MAY BE REQUIRED DUE TO EXCESSIVE LINT FROM CARPETING, BEDDING MATERIAL, PETS, ETC. IT IS IMPERATIVE THAT THE CONTROL COMPARTMENTS, BURNERS, AND CIRCULATING AIR PASSAGES OF THE APPLIANCE ARE KEPT CLEAN AND FREE OF OBSTRUCTIONS. (S'ASSURER QUE LE BRÛLEUR ET LE COMPARTIMENT DES COMMANDES SONT PROPRES. VOIR LES INSTRUCTIONS D'INSTALLATION ET D'UTILISATION QUI ACCOMPAGNENT L'APPAREIL.)**

 **WARNING: DO NOT OPERATE THIS APPLIANCE WITH THE GLASS, OR ANY PANEL REMOVED, CRACKED, OR BROKEN. DO NOT SUBJECT THE DOOR TO ABUSE, SUCH AS STRIKING OR SLAMMING SHUT. ONLY A LICENSED OR QUALIFIED SERVICE PERSON SHOULD REPLACE THE GLASS PANEL WHEN NECESSARY.**

Never Burn Paper, Wood or Other Materials

This gas heater is designed to burn natural gas (NG) or liquid propane (LP). Never burn any fuel not intended for use with this unit.

Hot Surfaces

Certain exposed surfaces of the Tribute DV will reach high temperatures during normal operation. Ensure clearances to combustibles are maintained, as specified in the "Clearances to Combustibles" section of this manual.

Do not use this appliance if any part was submerged. Immediately call a qualified service technician to inspect the heater and to replace any part of the control system and gas control that was submerged. *(Ne se servir de cet appareil s'il a été plongé dans l'eau, complètement ou en partie. Appeler un technicien qualifié pour inspecter l'appareil et remplacer toute partie du système de contrôle et toute commande qui ont été plongés dans l'eau.)*

 **WARNING: DO NOT CONNECT THIS GAS APPLIANCE TO A CHIMNEY FLUE SERVING A SEPARATE SOLID-FUEL BURNING APPLIANCE. NEVER VENT THE GAS HEATER INTO OTHER ROOMS OR BUILDINGS. MASONRY CONVERSIONS KITS ARE AN ACCEPTABLE VENTING OPTION.**

Due to high temperatures, locate the appliance out of traffic and away from furniture, draperies, clothing and flammable materials. Alert children and adults to the hazards of high surface temperatures so they can avoid burns to skin or prevent clothing ignition. Supervise young children carefully when they are in the same room as the appliance. Never place clothing or other flammable material on or near the appliance. *(Surveiller les enfants. Garder les vêtements, les meubles, l'essence ou autres liquides à vapeur inflammables loin de l'appareil.)*

 **FIRE HAZARD: DO NOT STORE OR USE GASOLINE OR OTHER FLAMMABLE VAPORS OR LIQUIDS IN THE VICINITY OF THIS APPLIANCE.**

 **REPLACE ANY SHIELD, DOOR, OR SAFETY SCREEN COMPONENT REMOVED FOR SERVICING PRIOR TO OPERATING THE UNIT.**

Certified for use by:

Board of State Examiners of Plumbers and Gasfitters
100 Cambridge Street, Room 1511
Boston, Massachusetts 02202

**SPECIFIED VENTING MANUFACTURER CONTACT
INFORMATION**

Simpson Dura-Vent

www.duravent.com/
(800)835-4429
customerservice@duravent.com

American Metal Products

www.americanmetalproducts.com/vent/amerivent.htm
1-800-423-4270
info@americanmetalproducts.com

Selkirk Corporation

<http://www.selkirkinc.com/>
1.800.992.VENT (8368)
sales@selkirkinc.com
custsvc@selkirkinc.com

Security Chimneys International

<http://www.securitychimneys/>

This product is manufactured, and warranted by:

Hearthstone *Quality Home Heating Products, Inc.*
317 Stafford Avenue,
Morrisville, Vermont 05661-8695
E-Mail: Inquiry@Hearthstonestoves.com
www.Hearthstonestoves.com

SPECIFICATIONS

LISTED AS: Gas-Fired Direct-Vent Fireplace Heater

Model: Tribute DV Model 8050 Direct-Vent Gas
Fireplace Heater

Testing Agency: Intertek Testing Services, Inc.

Tested to: ANSI Z21.88b – 2008/CSA 2.33b - 2008

Certified for Canada, CSA P.4.1

Approved for Mobile Home Installation

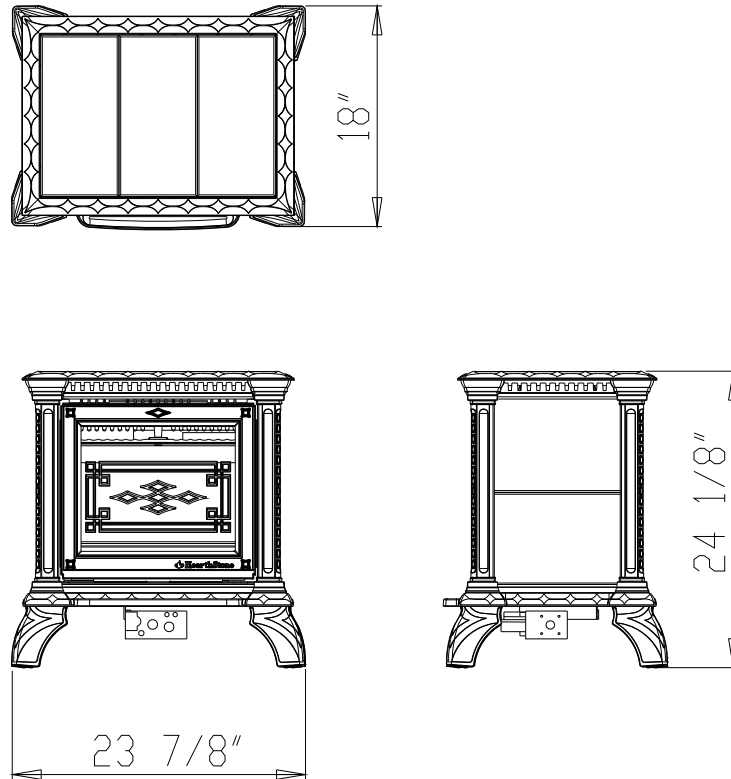

Figure 1: Tribute DV Dimensions

Specification	NG	LP
INPUT RATING (Btu/hr) 0-2000 ft	18,000	17,500
ORIFICE SIZE (DMS) 0-2000 ft	48	56
ORIFICE SIZE (DMS) 0-4500 ft	48	56
MANIFOLD PRESSURE - LO SETTING (in. W.c./kpa)	1.2/0.30	3.3/0.82
MANIFOLD PRESSURE - HI SETTING (in. W.c./kpa)	3.5/1.15	10.0/2.48
INLET PRESSURE - LO (in.w.c./kpa)	5.0/1.24	10.0/2.48
MINIMUM INPUT RATING (btu/hr)	10,600	10,400
MAXIMUM OUTPUT (btu/hr) 0-2000 ft	13,300	13,200

OWNER'S INFORMATION

The installation must conform with local codes or, in the absence of local codes, the current National Fuel Gas Code, ANSI Z223.1 (NFPA 54) or CAN/CSA B149 Installation Code. *(Installer l'appareil selon les codes ou règlements locaux, ou, en l'absence de tels règlements, selon les Codes d'installation CAN/CSA-B149.)*

DAILY OPERATION

The Tribute DV is easily operated by the homeowner once installed and adjusted by qualified service personnel. The unit can be controlled via the wall-mounted thermostat during the heating season. Set the thermostat to the desired room temperature and the unit will cycle on and off as required. By adjusting the variable output control located on the gas control valve, the rate of heat output can be varied to meet the heating requirements of the season. Choosing a low flame setting will result in longer burn cycles at a reduced output, while choosing a high flame setting will result in a shorter, hotter burn cycle. Through trial and error, the homeowner can select the optimum flame size for their setting and application.

EFFICIENCY

During the summer non-heating season, switch the wall thermostat to "OFF", and turn off the pilot. This will improve the overall efficiency of the unit as the heat from the pilot is wasted. When putting the unit back into service, follow the lighting instructions described on page 24.

CONDENSATION

Fuel gasses produce water vapor when burned. Therefore, when the unit is first lit, especially when

cool, it is normal to experience some condensation on the inside of the window glass. This condensation will burn off within the first few minutes of operation. If continuous condensation on the window glass or dripping water from any part of the unit or venting system (chimney) is noted, immediately discontinue operation of the unit and contact qualified service personnel.

CLEANING

Clean the area around, under, and behind the unit on a regular basis to prevent the accumulation of dust and lint.

The Tribute DV requires minimal routine maintenance and care. It should always be cool and off when being cleaned, or serviced. Once a year, the unit, and venting system should be inspected by qualified service personnel to insure that they are clean, free of obstruction, safe, and in good working order. If service or maintenance is required, qualified service personnel should perform it.

SERVICE CAUTION

If you believe your Tribute DV is not, in any way, performing properly, immediately discontinue operation until the unit has been inspected and approved by qualified service personnel. Prior to servicing the unit, turn the valve control knob clockwise to "OFF". The unit should be cool prior to servicing and cleaning. Use of any components not supplied by Hearthstone on the stove voids all warranties. **Do not substitute components.**

INSTALLER'S INFORMATION

CODES

Adhere to **all local codes** or, in their absence, the latest edition of THE NATIONAL FUEL GAS CODE ANSI Z223.1 (NFPA 54) or CAN/CSA B149 Installation Code that can be obtained from:

AMERICAN NATIONAL STANDARDS INSTITUTE, INC.

1430 BROADWAY
NEW YORK, NY 10018
www.ansi.org
OR













NATIONAL FIRE PROTECTION ASSOCIATION, INC.

BATTERY MARCH PARK
QUINCY, MA 02269
www.nfpa.org

The appliance, when installed with a blower, must be electrically connected and grounded in accordance with local codes or, in the absence of local codes, with the current NFPA 70-National Electrical Code or CSA C22.1-Canadian Electric Code.

A manufactured home (mobile) OEM installation must conform to the Manufactured Home Construction and Safety Standard, Title 24 CFR, Part 3280 (U.S.) or Standard for Manufactured Home Installation, ANSI/NCBCS A225.1 or Standard for Gas Equipped Recreational Vehicles and mobile Housing, CSA Z240.4.CAN/SCA Z240 MH (Canada). *(Installer l'appareil selon les codes ou règlements locaux, ou, en l'absence de tels règlements, selon les Codes d'installation CAN/CSA-B149.)*

ITEMS REQUIRED FOR INSTALLATION

-  External regulator (for propane/L.P.G. only)
-  Piping which complies with local codes
-  Pipe sealant approved for use with propane/L.P.G. (resistant to sulfur compounds)
-  Manual shutoff valve
-  Sediment trap (see page 17)
-  Tee joint
-  Pipe wrench
-  Phillips head screwdriver
-  7/16-inch wrench
-  Other parts as required by local code
-  *Safety Glasses
-  *Gloves

PACKING LIST

- 1-Tribute DV Gas-Fired Heater
- 1-TEK Burner
- 5-Decorative TEK Fire logs
- 1- Bag Platinum Bright Embers
- 1-Owner's Manual
- 1-Thermostat
- 1-40' Thermostat wire
- 1-Warranty Validation Form

Note: Vent kits and components are supplied separately. Failure to use the venting components specified by Hearthstone QHHP, Inc. will void your warranty and could risk a fire.

UNPACKING AND INSPECTION

Unpack and Inspect for Damage

The Tribute DV is packaged by the manufacturer to withstand shipment without damage. However, damage can still occur during transit; so take care to inspect for damage when unpacking and installing the unit. If any damage or missing parts are detected, immediately contact your dealer.

 **Do not install, or put into service, a damaged or incomplete heater.**

Inspect the Tribute DV for visible or concealed damage. The unit should appear to be square and true. The sheet metal parts should be smooth and free of bends and dents. The enameled cast iron should be free of chips or cracks. If visible or concealed damage is found or suspected, contact your dealer for instructions.

With the accessory box removed and set aside, take care not to mar or chip the enameled legs, if applicable. Have someone help lift the stove out of the shipping box and set it into place.

The TEK Burner and TEK Fire logs supplied with the Tribute DV are contained in the accessory box. Always use great care when handling the decorative fire logs, as they are fragile and subject to damage and breakage if handled roughly. If a broken log is encountered, contact your dealer for replacement logs. Otherwise, set the logs aside until called for during the installation.

INSTALLING THE TRIBUTE DV

HEARTH REQUIREMENT/FLOOR PROTECTION

The Tribute DV may be placed on a noncombustible surface or wood floor. Installations must meet local codes.

CLEARANCE TO COMBUSTIBLES

Due to high surface temperatures, the unit should be located out of traffic and away from furniture and draperies. Clothing and other flammable material should not be placed on or near the heater. When positioning the unit always maintain adequate clearances around air openings into the combustion chamber and allow for adequate ventilation.

Minimum clearances to combustibles must be maintained as shown in the illustrations of the *Clearances To Combustibles* section.

CAUTION: THESE CLEARANCES REPRESENT *MINIMUM* DISTANCES IN ALL CASES, WHICH, THROUGH TESTING IN AN INDEPENDENT LABORATORY TO ANSI AND CSA STANDARDS, WILL PREVENT FIRE OR SPONTANEOUS COMBUSTION. WE DO NOT CONTROL THE COMBUSTIBLE MATERIALS EXPOSED TO HEAT BY THIS PRODUCT; THEREFORE, AN ASSESSMENT MUST BE MADE BY THE INSTALLER TO PREVENT CONSEQUENTIAL DAMAGE OF WALLS AND FLOORING.

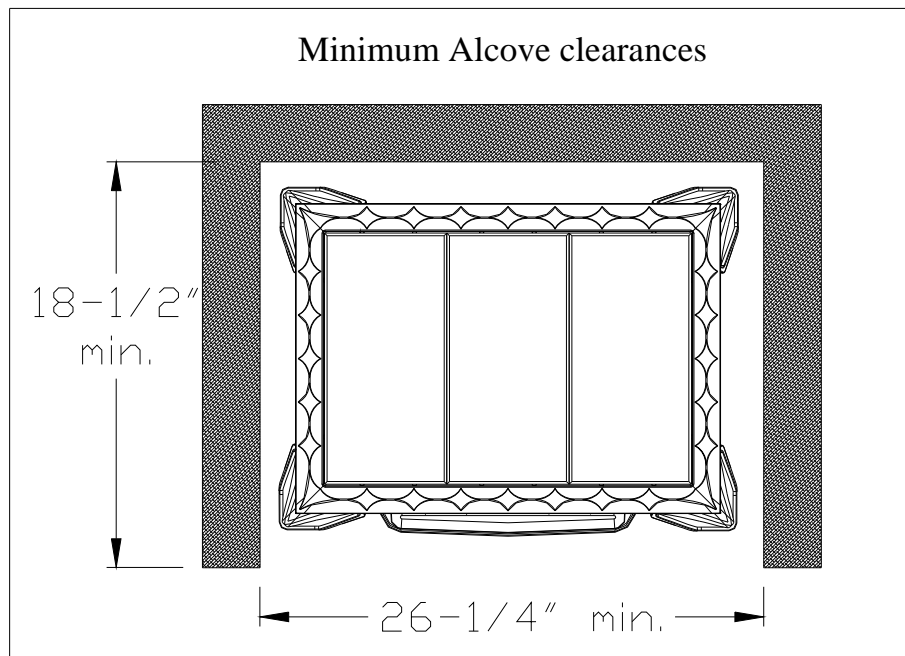

Clearances to Combustibles

Unit top to side wall	2"
Unit top to rear wall	2"
Unit top to corner wall	2"
Unit top to corner wall	2"
Unit top to ceiling	9"

Figure 2: Clearance to combustibles

ACCEPTABLE DIRECT-VENT TERMINATION CAP LOCATIONS

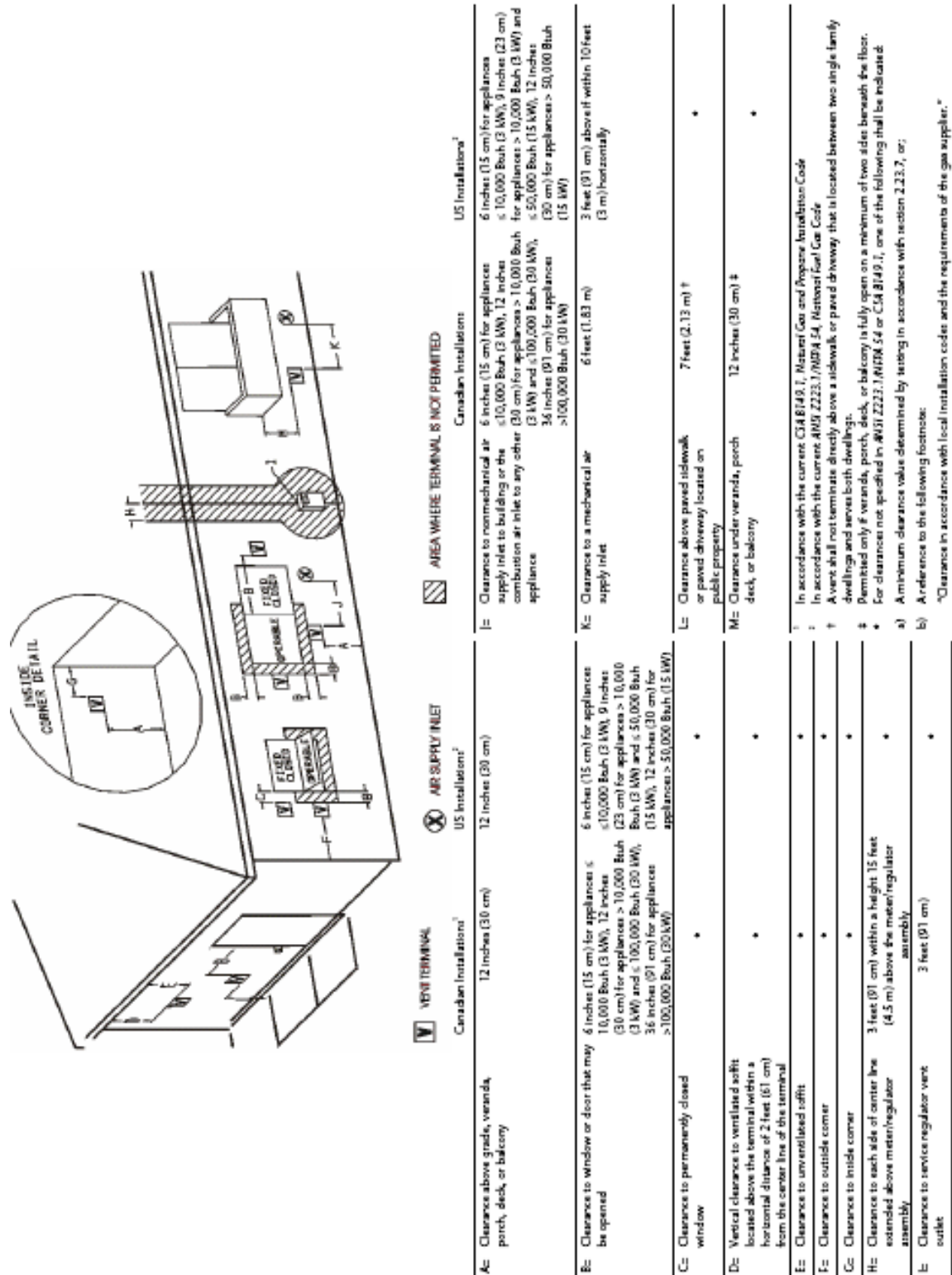

Figure 3: Termination Location clearances

VENTING INFORMATION

VENT CONNECTION

1. The Tribute DV Direct Vent is approved for installation only with the vent connecting components listed; Simpson Dura-Vent Direct Vent GS, AmeriVent Direct, Selkirk Direct Temp™ EXCELDirect or Secure Vent systems.
2. Install the vent system according to the manufacturer's instructions.

RESTRICTION PLATE

There is a vent restriction plate that adjusts the flow rate of exhaust gases. This insures proper flames and efficiency for the wide variety of vent configurations. Controlling the draft also changes the aesthetics of the flame. The restriction plate consists of a rotating shutter behind the starter section of pipe and an adjustment plate with an index hole used to hold the shutter in a fixed position. The restriction plate has unlimited settings. Depending on the vent configuration, you may be required to adjust the restriction plate position. **For straight out the back installations no adjustment to the restrictor is necessary.**

ADJUSTMENT TO RESTRICTION PLATE

Make sure the unit is cool before touching any part of the firebox. To adjust your restrictor for maximum flame appearance, loosen the Phillips head screw, found on the upper rear right side of the stove. Spin the indicator tab into the desired position. Rotating counterclockwise closes the exhaust gasses, while rotating clockwise opens the exhaust gases. Once the desired restriction is reached, tighten the screw. There are unlimited positions for the restriction plate, one (1) being the lowest and three (3) being the highest. (Refer to Venting Configuration – *Figure 4* for recommended restriction plate positions)

NOTE: These positions are based on lab results and can have some variance.

VENT PIPE CLEARANCES

All flue vent pipe for the Tribute DV must be installed with the following clearances to combustibles.

1" - For vertical pipe

1" - Below and along the side of all horizontal pipes.

2" - On top of all horizontal pipes.

VENTING COMPONENTS & CONFIGURATION

The Tribute DV cannot be vented jointly with any other solid fuel or gas appliance. It must be vented directly to the outside of the building using a proper termination as listed in the manual. The only types of venting pipe approved for use with your Tribute DV Direct-Vent stove is Simpson Dura-Vent's GS, AmeriVent Direct, Selkirk Direct Temp™ EXCELDirect and Secure Vent Direct-Vent Pipe. The venting configuration is shown in *Figure 5 (with the optional snorkel)*, and *Figure 6 showing the minimum vent kit*. After determining the venting configuration for your stove, select the vent system that will accommodate your installation.

CAUTION: ENSURE THERE IS NO WIRING OR PLUMBING IN THE CHOSEN LOCATION.

CAUTION: DO NOT RECESS VENTING TERMINALS INTO A WALL OR SIDING.

Note: If further direction is needed for installation, please refer to the venting instructions, which are provided with the venting components.

ACCEPTABLE DIRECT-VENT TERMINATION CAP LOCATIONS

The vent/air intake termination clearances above the high side of an angled roof are as follows:

Roof Pitch	Feet	Meters
Flat to 6/12	1	0.3
7/12 to 9/12	2	0.6
10/12 to 12/12	4	1.2
13/12 to 16/12	6	1.8
17/12 to 21/12	8	2.4

Listed are Simpson Dura-Vent, AmeriVent Direct, **Selkirk Direct Temp™** and Secure Vent components acceptable for installation, along with the minimum venting kit available. The venting system must be comprised of the appropriate venting components as specified.

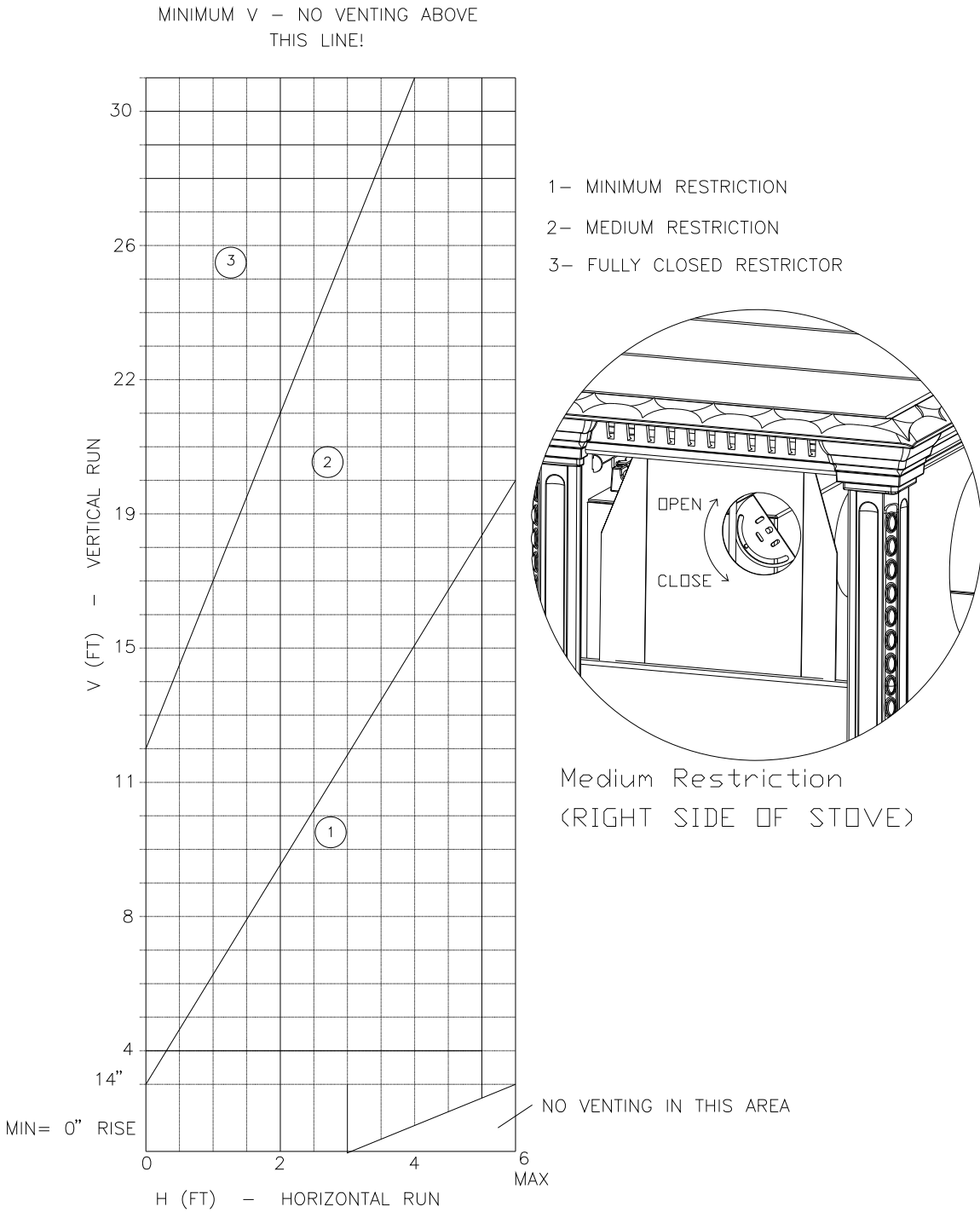

RESTRICTOR WIDE OPEN WITH UNDER 14" VERTICAL VENT
 MINIMUM HORIZONTAL = 6"
 MAXIMUM HORIZONTAL = 6' WITH 14" RISE

Figure 4: Venting Restrictor configurations

APPROVED VENTING SYSTEM COMPONENTS

(The following are components that are available, but not necessary for all installations)

- 🔥 90° Elbow
- 🔥 45° Elbow
- 🔥 6" Straight
- 🔥 9" Straight (Simpson only)
- 🔥 12" Straight
- 🔥 24" Straight
- 🔥 36" Straight
- 🔥 48" Straight
- 🔥 11"-14 5/8" Adjustable Pipe Length
- 🔥 Horizontal Vent Cap
- 🔥 Vertical Vent Cap
- 🔥 14" Snorkel
- 🔥 Vinyl Siding Standoff 4 x 6 5/8"
- 🔥 Round Ceiling Support Wall

- 🔥 Thimble Covers
- 🔥 Wall thimble

CHIMNEY LINER SYSTEM

1. Direct-Vent Chimney Liner Termination Kit
2. Chimney Liner Flex
3. Co-Linear Flex Connector
4. Co-Axial to Co-Linear Appliance Connect)

MINIMUM VENT KIT

- 🔥 6" Straight
- 🔥 Wall Thimble Cover (optional)
- 🔥 Wall Thimble
- 🔥 Horizontal Vent Cap

Centerlines shown are approximate. Dry fit venting and take measurements. Pipe dimensions will vary by manufacturer and supplier.

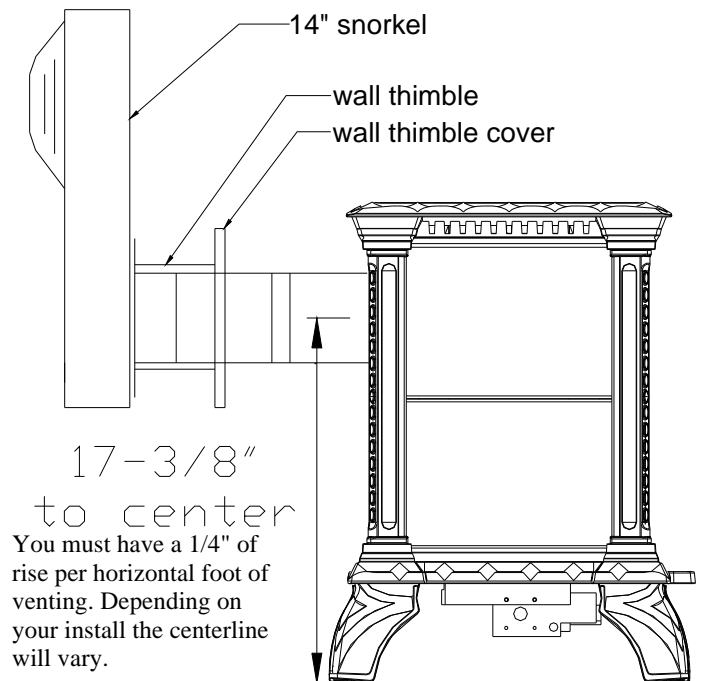

Figure 5: Components for a typical snorkel installation

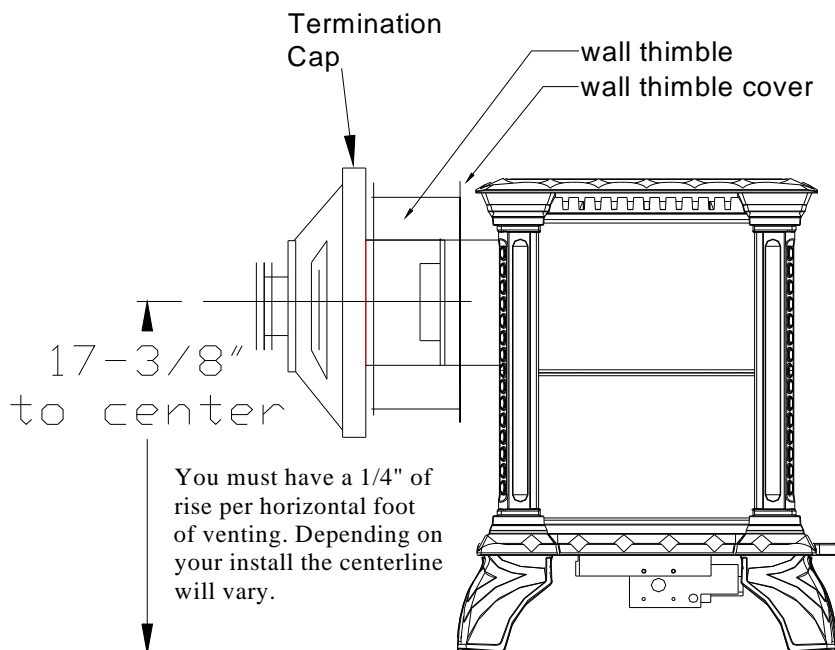

Figure 6: Components for a minimum horizontal vent configuration

INSTALLATION INSTRUCTIONS FOR THE STANDARD HORIZONTAL TERMINATION MINIMUM VENTING KIT

1. Install the straight over the outer collar.
2. Move the stove and pipe assembly back until the straight is flush to the wall. **Pull up on the pipe to ensure that there is a 1/4" per foot rise coming out of the stove.**
3. Draw a circle around the pipe. Use the center of this circle as the center point of the 10" x 10" square wall pass through. Cut and frame the wall pass through.
4. Place the interior wall thimble into the 10" x 10" wall pass through. Secure it with 4 screws (not provided). Install the exterior portion of the thimble in similar fashion, overlapping the 2 sections.

 **CAUTION: FOR BUILDINGS WITH VINYL SIDING, A VINYL SIDING STANDOFF SHOULD BE**

INSTALLED BETWEEN THE VENT CAP AND THE EXTERIOR WALL.

5. Install the horizontal vent termination on the outside of the wall. Make sure both of the retaining straps extend through interior wall thimble. Before attaching the vent termination to the outside of the house, run a bead of non-hardening mastic around its' outside edges, so as to make a seal between it and the wall. **The arrow on the end cap should point up.** Secure the cap to the wall with the appropriate screws.
6. Move the stove and vent pipe into position. Make sure the vent pipe extends into the horizontal vent cap a minimum of 1-1/4").
7. Secure the vent using the straps from the horizontal vent termination to the interior pipe with 2 sheet metal screws, keeping the screws close to the wall thimble as possible. Bend or cut the excess strapping, so that it is not visible after the installation is complete.

ELECTRICAL CONNECTIONS

 **NOTE: open valve door on the lower front of unit for electrical and gas connections.**

THERMOSTAT

The ON/OFF/T'stat switch or wall mounted thermostat controls the Tribute DV. We recommend installation of the thermostat for more comfortable performance, however you may still override the thermostat by setting the switch to "ON". The thermostat controls the unit by "calling for heat." The thermostat turns the unit on when the room is cold, and turns the unit off once the room is warmed sufficiently. The thermostat is controlled by a 750 millivolt DC two-wire circuit.

REMOTE CONTROL

There are two different optional remote controls available for the Tribute DV. Both of the remote controls are capable of turning the unit on and off. One of the optional remotes also allows you to control the temperature of the stove, (in the same way the thermostat controls the heater), from anywhere in the vicinity of the unit. If "ON" & "OFF" are the only controls required, Kit #90-56912 can be used. If you would like to control the temperature via the remote control, use Kit #90-56914. Installation instructions are provided with the kits.

THERMOSTAT PLACEMENT

The thermostat should be placed in the same room or living space as the unit. Typically 5' (1.5m) off the floor and away from any influences that may cause the temperature in the vicinity of the thermostat to be unrepresentative of the room temperature in general. Such influences might include strong lighting, a heater vent from the central heating system, or a nearby drafty window.

Placement of the thermostat on an inside wall rather than an outside wall is preferable. Do not place the thermostat directly behind or too close to the unit, otherwise heat from the unit will immediately satisfy the thermostat and turn the unit off.

THERMOSTAT WIRING

The thermostat should be connected to the Tribute DV using no more than 40' (12 m) of the provided insulated thermostat wire. The thermostat wire from the Tribute DV to the thermostat can be surface mounted or routed under the floor, through walls, etc.

Be sure to leave a small coil of additional thermostat wire behind the Tribute DV so that the unit can be moved out of position for servicing and cleaning.

Connect one of the thermostat wires to the gas control marked **TH** and the other to the yellow wire coming from the on/off T'stat switch. When making these connections, position the thermostat wire so that it extends towards the wall behind the Tribute DV, then towards the thermostat.

At the thermostat, the wires should be connected to the two connection screws on the back of the thermostat per the instructions received with the thermostat. Take care not to over-tighten the connection screws and not to damage the internal parts of the thermostat.

WIRING INSTRUCTIONS

CAUTION: LABEL ALL WIRES PRIOR TO DISCONNECTION WHEN SERVICING CONTROLS. WIRING ERRORS CAN CAUSE IMPROPER AND DANGEROUS OPERATION. VERIFY PROPER OPERATION AFTER SERVICING. (ATTENTION: AU MOMENT DE L'ENTRETIEN DES COMMANDES, ÉTIQUETEZ TOUS LES FILS AVANT LE DÉBRANCHEMENT. DES ERREURS DE CÂBLAGE PEUVENT ENTRAÎNER UN FONCTIONNEMENT INADEQUAT ET DANGEREUX.) THE PROPER LOCATION OF WIRE CONNECTIONS IS SHOWN IN FIGURE 7.

Wiring Diagram - Tribute

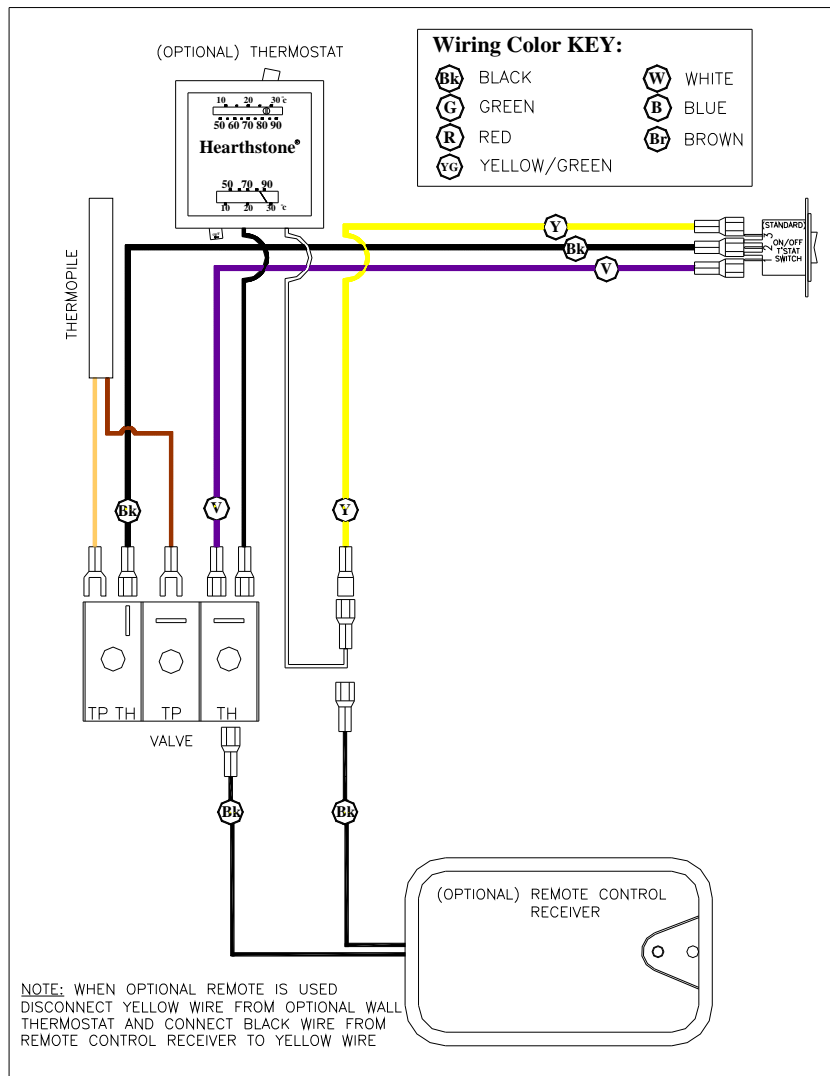

Figure 7: Tribute 8050 Wiring diagram

GAS SUPPLY & CONNECTIONS

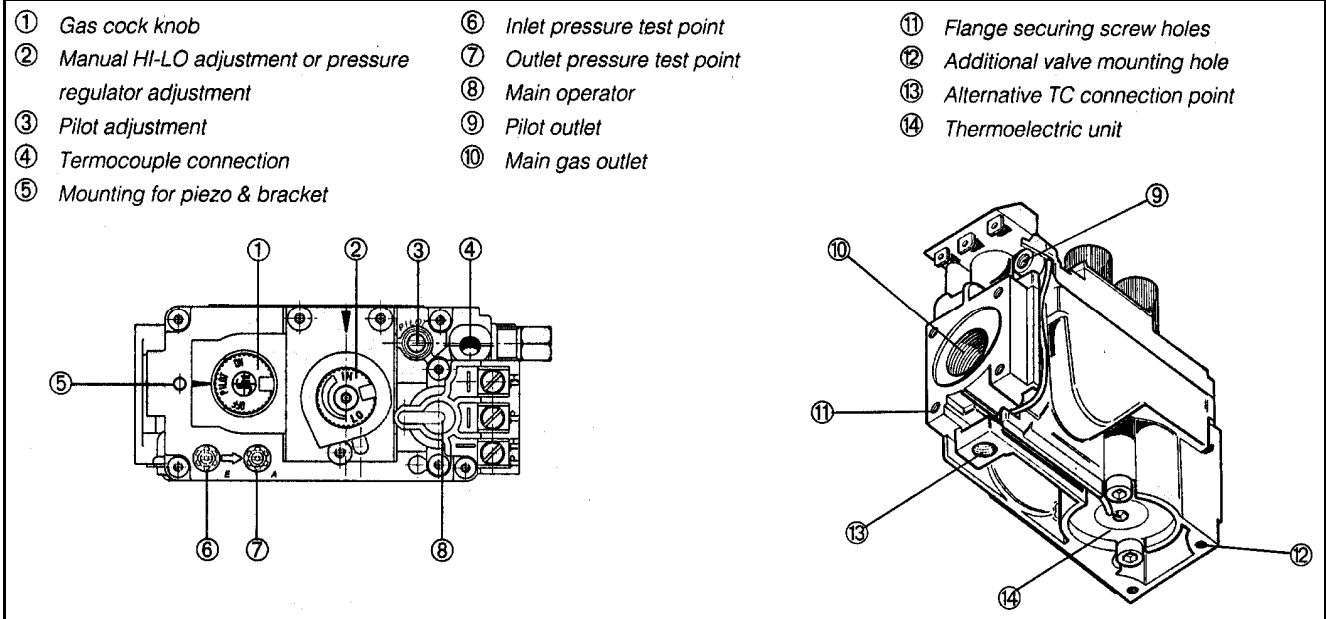

Figure 8: Gas control valve

WARNING: THE UNIT MUST BE INSTALLED AND CONNECTED IN ACCORDANCE WITH LOCAL CODES, OR IN THE ABSENCE OF LOCAL CODES, WITH THE MOST CURRENT EDITION OF THE NATIONAL FUEL GAS CODE ANSI Z223.1 (NFPA 54) OR CAN/CSA B149 INSTALLATION CODE.

NOTICE: A qualified technician must connect the heater to the gas supply and leak test the unit before it is approved for use. Consult all codes.

WARNING: NFPA Code and Hearthstone require the use of a dedicated sediment trap just upstream of the unit. Damage to the valve, or other components due to the lack of a sediment trap are not covered by warranty.

GAS CONNECTIONS

The gas supply connection is made to the Tribute DV's gas control valve in the middle of the lower rear of the stove, using a 3/8" male NPT fitting. The supply line should be 1/2" diameter, or appropriately sized to provide a sufficient gas supply to meet the maximum demand of the unit without undue loss of pressure. We recommend a flexible line to avoid undue mechanical load on the valve and to ease thread alignment, but refer to local codes.

CAUTION: CHECK GAS TYPE!

GAS SUPPLY

This appliance and its individual shutoff valve must be disconnected from the gas supply piping system during any pressure testing of that system at test pressures in excess of 1/2 psig. The Tribute DV must be isolated from the gas supply piping system by closing its individual manual shutoff valve during any pressure testing of the gas supply piping system at test pressures equal to or greater than 1/2 psig.

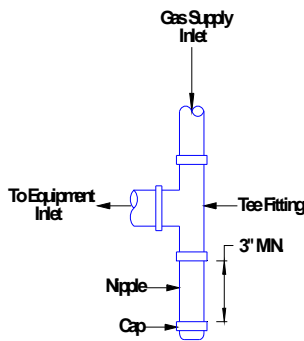

Figure 9: Typical Sediment Trap (Required in all installation)

GAS PRESSURE ADJUSTMENT

 **NOTE: A QUALIFIED TECHNICIAN MUST PERFORM THIS PROCEDURE!**

Once connected to the gas supply, the supply line and manifold gas pressures must be tested. The supply line pressure is tested, to insure it meets the minimum gas supply pressure as listed in the

Specifications for the type of fuel in use (natural gas or LP), by connecting a manometer to the supply line and adjusting the incoming pressure if necessary to meet the required supply line pressure as listed in specifications. The manifold pressure tap on the gas control valve, refer to *Figure 8* for location.

LOG PLACEMENT

CAUTION: FRAGILE! HANDLE LOG SET WITH CARE. ALWAYS WEAR GLOVES AND SAFETY GOGGLES WHILE HANDLING THE LOG SET.

Place only the ceramic log set supplied with the unit in the firebox. Do not place any other ceramic logs, wood logs, or other materials in the firebox. If the log set is damaged or broken contact your dealer for replacement. The ceramic log set will last a long time, however, they will break if subjected to rough or improper handling. Exact positioning of the log set is required in order to obtain a pleasing flame pattern and efficient combustion. Incorrect log placement may cause carbon build-up; excess thermal stress on the log set and stove parts, reduced efficiency, and high levels of carbon monoxide. If the log set does not set into the firebox exactly as outlined, contact your dealer for assistance.

INSTALLATION OF THE LOG SET

(Refer to the following images in this section for log set assembly).

1. Lift off the cast iron front of the front unit, and remove the glass assembly. To remove the front, grasp both sides of the front cast facade, and lift upward and then outward. Set the front aside taking care not to chip or scratch the enamel. Next, locate the two rotating clips above the glass. Rotate the clips out of the "locked" position and tilt the top of the glass outward. Lift the entire glass assembly up and out.
2. Remove the packaging material around the log set assembly. Be careful not to damage the log set when unpacking.
3. Set the two bottom logs in position as shown in the photo below.

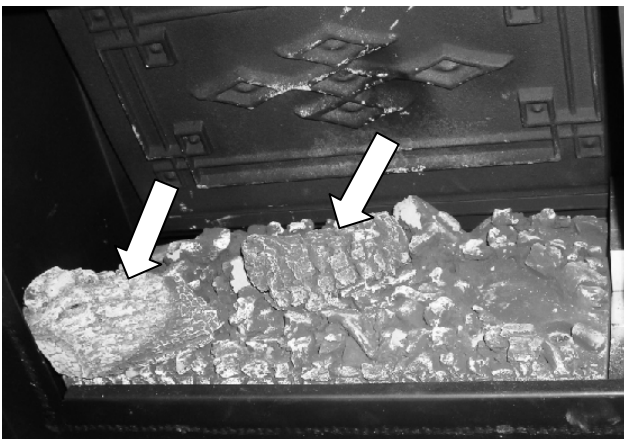

4. Set Rear Log in place as shown in the following photo.



5. Set the Top Left Log in place, using the locating recess on the bottom that interlocks with locating tab on the top of the Bottom Left Log. Place the Right Log in place as shown in the photo below.

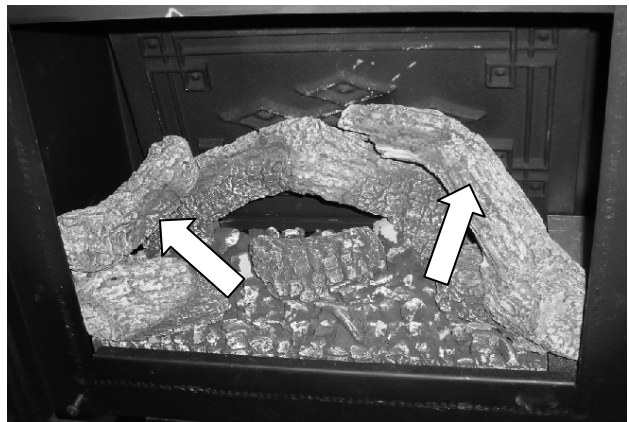

6. Open the bag of Platinum Bright Embers. Fluff up the pieces and spread them randomly over the logs and burner. These embers will glow brightly when the unit is running.
7. Replace the front glass assembly and front cast façade before relighting the unit.

CAUTION: Place only the Fire log set supplied with the Tribute DV in the firebox. Do not place any other logs, wood logs, or other materials in the firebox. If the log set is damaged or broken contact your dealer for replacement. It must be replaced with the same approved replacement parts.

REMOVAL OF LOG SET

 **CAUTION: THE FIRELOG SET RETAINS HEAT AND CAN BE VERY HOT! ALLOW 2 TO 3 HOURS AFTER PILOT LIGHT IS TURNED OFF BEFORE HANDLING.**

To remove the Fire log set, follow the Installation of Log Set instructions in the reverse order.

STONE INSTALLATION

Standard Stone Kit Contents:

3-Top Stones: 6-3/8" x 13-1/8"
4-Side Stones: 7-3/4" x 10-3/4"

Standard Kit Part Numbers:

9050-41 Polished Soapstone
9050-63 Aztec Green Marble
9050-53 Autumn Brown Granite
9050-51 Dakota Red Granite
9050-56 Misty Mauve Granite
9050-55 Orion Black Granite

Optional Rear Stone Kit Contents:

1- Left Rear Stone: 8-5/16" x 14-7/8"
1- Right rear Stone: 8-5/16" x 14-7/8"

Rear Kit Part Numbers:

9055-41 Polished Soapstone
9055-63 Aztec Green Marble
9055-53 Autumn Brown Granite
9055-51 Dakota Red Granite
9055-56 Misty Mauve Granite
9055-55 Orion Black Granite

Top & Side Stone Procedure:

 **Note: Always work on a cold stove. Use care in handling stones and enamel front to avoid chipping and scratching of parts.**

1. Identify and lay out the stones based on the description above.
2. Remove the cast top from the stove by carefully lifting up, taking care not to chip the edges.
3. Note the steel side stone clips/heat shields already in place (used to retain the side stones).
4. Slide the side stones (**7-3/4" x 10-3/4"**) down in front of the heat shields through the slots in the top with the polished side facing out. To avoid scratching and to make sliding easier, ensure you keep the stones back from the corner braces as you slide them down. Install only one stone at a time. Do not use one stone to push the other down (See following image).
5. Replace the top casting on the stove.
6. Lay top stones into place starting from one side to the other.



Inserting the Side Stones

Rear Stone Procedure

 **Note: Always work on a cold stove. Use care in handling stones and enamel front to avoid chipping and scratching of parts.**

1. Remove the existing rear panels from the stove by removing the four Phillips head screws holding them in place. Reinsert the screws to plug the existing holes.
2. Install the rear stones by inserting the outside edge first and then rotating the stone in. The stone will drop down into a channel once parallel to the back of the stove.
3. Repeat with second stone.

LIGHTING THE UNIT FOR THE FIRST TIME

 **WARNING: IF YOU DO NOT FOLLOW THESE INSTRUCTIONS EXACTLY, A FIRE OR EXPLOSION MAY RESULT CAUSING PROPERTY DAMAGE, PERSONAL INJURY OR LOSS OF LIFE.**

 **CAUTION: LIGHTING THE TRIBUTE DV FOR THE FIRST TIME AND ADJUSTMENTS TO THE UNIT SHOULD BE PERFORMED BY QUALIFIED SERVICE PERSONNEL ONLY.**

This appliance is only for use with the type(s) of gas indicated on the rating plate. This appliance is not convertible for use with other gases, unless a certified kit is used.

(Cet appareil doit être utilisé uniquement avec les types de gas indiqués sur la plaque signalétique. Ne pas l'utiliser avec d'autres gas sauf si un kit de conversion certifié est installé.)

SMOKE AND FUMES WARNING

When lit for the first time, the Tribute DV will emit some smoke and fumes. This is normal “off-gassing” of the paints and oils used in the manufacturing and assembly of the unit. Open windows to vent the room if necessary. The off gassing and fumes will subside after the first 10 to 20 minutes of operation.

ODORS AND IMPURITIES

A heater of this type may produce odors during heater operation due to impurities that may exist in the immediate area. Sources of impurities can be cleaning solvents, paint solvents, cigarettes, candles, smoke, pet hair, dust, adhesives, new carpet, and/or textiles. Such odors will dissipate. However, opening a window or otherwise providing additional ventilation to the area can alleviate the condition. If any odor persists, contact your dealer or an authorized service technician.

PILOT LIGHT WARNING

The Tribute DV has a piezoelectric spark igniter (the red push button located next to the gas control valve behind the valve access door), which ignites the pilot light by means of a spark at the pilot light assembly. Do not attempt to light the unit with a

match or by any means other than the piezoelectric spark.

DO NOT LIGHT PILOT OR BURNER BY HAND

The standing pilot light on this gas heater is lit by using a piezoelectric spark generator as described elsewhere in this manual. Never attempt to light the pilot or main burner by hand with a match or lighter. If, after repeated attempts, the pilot light fails to light, discontinue operation; turn off the gas at the gas control valve, and immediately contact qualified service personnel for assistance.

PREPARE FOR LIGHTING

Prepare for the lighting procedure by adjusting the thermostat (if equipped) to its lowest setting or OFF position. If the gas control knob is not in the OFF position, turn the knob fully clockwise to OFF. Locate the variable output control knob and turn it fully clockwise to the highest setting.

Prior to lighting the unit for the first time, wait 5 minutes to allow any residual gas within the unit to dissipate. Smell all around the appliance area for gas. Be sure to smell next to the floor because some gases are heavier than air and will settle on the floor. If you do not smell gas after this five-minute period, proceed with the lighting procedure. If you do smell gas, **DO NOT** proceed with the lighting procedure. Instead, **immediately refer to the What To Do If You Smell Gas Warning, on the cover of this manual.**

 **WARNING: THE VALVE CONTROL HAS AN INTERLOCK DEVICE. AFTER SHUTTING OFF ALL GAS FLOW, THE PILOT BURNER CANNOT BE RELIT UNTIL THE THERMOCOUPLE HAS COOLED, ALLOWING THE ELECTROMAGNET TO BE RELEASED (APPROX. 60 SECONDS). THE GAS CONTROL KNOB IS DESIGNED TO OPERATE BY HAND. DO NOT USE ANY TOOLS DURING THIS OPERATION. DAMAGED KNOBS MAY RESULT IN SERIOUS INJURY.**

INITIAL ADJUSTMENTS

Once the Tribute DV is in place, connected and assembled as described in the “Clearances To Combustibles”, “Venting Components & Configurations,” “Electrical Connections”, and “Gas Supply and Connections” sections of this manual, the unit is almost ready to be lit for the first time. The manufacturer tests each unit prior to shipment, so ignition should take place without failure. However, a number of small adjustments may be necessary to compensate for variations in gas pressure, altitude, and other factors particular to each installation.

VARIABLE OUTPUT CONTROL

The gas control valve is equipped with a variable output control. This control varies the rate of heat produced by the unit by varying the gas pressure to the TEK Burner. A combination of heat output and the thermostat setting affect the length of the burn cycle. If your stove turns on and off too often, try, first, reducing the burn cycle by turning the HI/LOW knob, on the control valve, to a lower setting. Using the variable output control, the heat output of the unit can be reduced for mild fall and spring months, or maximized for the colder winter months. This adjustment can be made, by the homeowner, as necessary by turning the variable output control knob to “HI”, “LO” or any setting in between.

LIGHTING INSTRUCTIONS

 **NOTE:** The gas control knobs and the piezo igniter are located under the front of the unit.

1. STOP! Read the What To Do If You Smell Gas! Warning (on the cover of this manual).
2. Set the on/off/T’stat switch or thermostat to the “OFF” position.
3. Push in and turn gas control knob clockwise to “OFF”. (*If not previously lit, the knob should be in this position.*)
4. Wait (5) five minutes to clear out any gas. If you then smell gas, STOP! *Smell all around the appliance area for gas. Be sure to smell next to the floor because some gases are heavier than air and will settle on the floor. **If you smell gas immediately follow the What To Do If You Smell Gas! warning on the cover of this Manual.*** If you do not smell gas, proceed to the next step.
5. Turn gas control knob counter-clockwise to “PILOT”.

6. Push in control knob all the way and hold in. Immediately light the pilot with the gas lighter (push in and “click” the piezoelectric spark igniter button several times until lit). Continue to hold the control knob in for about 20 seconds after the pilot is lit. Release the knob and it will pop back out. Pilot should remain lit. If the pilot goes out, repeat the operation.

 If knob does not pop out when released, stop, shut off the gas supply to the heater and immediately call a qualified service technician or gas supplier.

 If the pilot will not stay lit after several tries, turn the gas control knob “OFF” and call a qualified service technician or gas supplier.

7. After the pilot lights, turn gas control knob counter-clockwise to “ON”.
8. If the ON/OFF/T’stat switch is set to “ON”, the stove should now be lit. If the thermostat (or remote) has been installed, set the ON/OFF/T’stat switch to “T’stat” and turn the thermostat (or remote) to “ON”. Then set the desired temperature.
9. Shut the gas control valve access door.
10. Plug in the fan accessory, if so equipped.
11. If T’stat was selected, set thermostat to “ON” and set desired temperature setting. Normally, if T’stat position was selected, the main burner is cycled on and off by the thermostat or the “on/off” switch located on the bottom of the thermostat body.

 **NOTE:** When pressing/clicking the piezoelectric spark ignition button to light the pilot, watch through the glass (front) of the unit. Click the igniter button until a flame is visible at the pilot. Once the pilot is lit, continue to press on the gas control knob for another 20 seconds, then release. Ascertain that the pilot is still lit by looking through the front door. If lit, then turn the gas control knob fully counter-clockwise to the “ON” position. If the pilot fails to light, or if it went out due to a premature release of the gas control knob while depressed in the “PILOT” position, wait 60 seconds for the Interlock to release. Then repeat the lighting process as described in this section of the manual.

Once the pilot has been lit, the gas control knob has been turned to the “ON” position, and the

ON/OFF/T'stat switch has been turned to "ON", the main burner should light immediately. If you would like to use the thermostat and it has been installed, switch the ON/OFF/T'stat switch to thermostat. Turn the thermostat to "ON" and set it to a higher position so that it "calls" for heat in order to light the main burner (i.e. turns the unit on). Note that the thermostat controls the on/off cycling of the main burner, but the pilot remains lit regardless of the thermostat setting. The only way to turn the pilot off is to turn the gas control knob fully clockwise to the "OFF" position.

TO TURN OFF GAS TO APPLIANCE

1. Set the thermostat to the "OFF" position or turn the ON/OFF/T-STAT switch to the "OFF" position.
2. If shutting the unit off for the non-heating season, turn the gas control knob fully clockwise to the "OFF" position. Do not force the knob to turn.

AIR SHUTTER

The air shutter is used to regulate the air-to-gas combustion mixture, which in turn influences the size and color of the flames. The air shutter is positioned in the general location needed for the type of gas being used, however, if the unit is not burning as well as it should, then the air shutter may need adjusting. The air shutter may need adjustment once the unit has been installed to compensate for variations in supply line pressure, restriction plate position, altitude, gas type conversions, and other variables.

To determine if the air shutter needs adjustment, it is necessary to view the flame pattern with the variable output control knob at its highest setting. Allow the unit to operate for at least 10 minutes to allow the entire unit to reach temperature, and for the flame pattern to stabilize. Generally, the more air (open shutter) in the mixture, the bluer the flame. Less air (closed shutter) results in a more yellow flame, but too little air will result in incomplete combustion, low efficiency and a dirty burn. There are two simple guidelines to aid in determining the correct flame pattern:

1. If the flame at the base of the logs is completely blue, the air shutter may be open too far;
2. If the flame is dirty or licks the top of the stove, the air shutter may be closed too far.

Some conditions cannot be corrected through air shutter adjustment; an adjustment must be made to the gas supply pressure or by changing the restriction plate location. Qualified service personnel must perform supply line/manifold gas line pressure adjustments and restrictor plate adjustments. Do not attempt to complete any part of the installation or adjustment of this unit unless technically qualified to do so.

AIR SHUTTER ADJUSTMENTS

Loosen the air shutter locking nut prior to lighting the unit. This nut will get very hot after operation and will be difficult to loosen. Use a 5/16" wrench and loosen the nut on the slider adjuster under the firebox. Loosen the set nut and slider the adjuster to adjust the flame pattern. Use only metal tools for this adjustment. The air shutter adjuster, located under the front of the unit, is adjustable while the stove is burning. Slide the adjuster left to open the air shutter, and right to close the shutter. When the flame pattern is correct, tighten the set nut without letting slider move. The air shutter is factory set and only a qualified gas technician should make adjustments.

 **Note:** Very little movement is needed to substantially change the burn and flame patterns. Some conditions cannot be corrected through air shutter adjustment; an adjustment must be made to the gas supply pressure. Supply line/manifold gas line pressure adjustments must be performed by qualified service personnel. Do not attempt to complete any part of the installation or adjustment of this unit unless technically qualified to do so.

PILOT ADJUSTMENT

The pilot light is preset by the manufacturer and should not need adjustment. The pilot light flame should be large enough to engulf the thermopile and thermocouple located next to the pilot, but not so large as to create excessive noise or consume excessive gas. (Refer to figure 8) However, it can be adjusted by means of the pilot light adjustment screw located on the gas control valve. Open the valve door to access the pilot adjustment screw. Note that the pilot flame must engulf the thermopile so that the thermopile can generate sufficient millivoltage (325 to 500-mv) to power the gas control valve. The flame on the pilot should look like Figure 11. Controlling the Tribute DV by the wall-mounted thermostat may become erratic, nonexistent, or the unit may go out, if the pilot flame is too small or misdirected away from the thermopile.

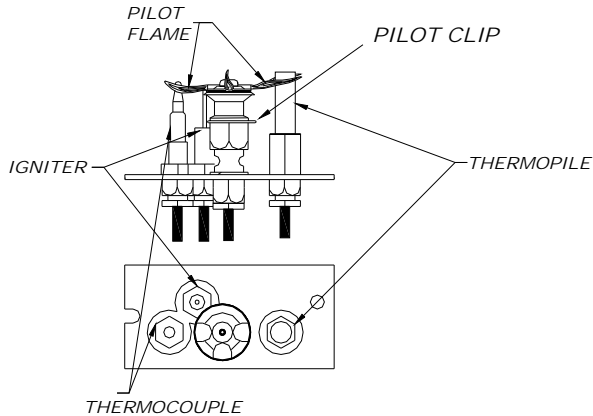

Figure 10: Pilot assembly

⚠ WARNING: THE CONTROL HAS AN INTERLOCK DEVICE. IF THE STOVE HAS BEEN LIT, IT WILL NOT RELIGHT IMMEDIATELY. AFTER SHUTTING OFF ALL GAS FLOW, THE PILOT BURNER CANNOT BE RELIT UNTIL THE THERMOCOUPLE HAS COOLED, ALLOWING THE ELECTROMAGNET TO BE RELEASED (APPROX. 60 SEC.). THE GAS CONTROL KNOB IS DESIGNED TO OPERATE BY HAND. DO NOT USE ANY TOOLS DURING THIS OPERATION.

BURNER FLAME APPEARANCE

Once the unit is lit, observe the flame pattern and adjust as necessary. Also, a periodic visual check of the burner flame should be performed. The burner flames can be adjusted by means of the air shutter. To determine if the burner flame needs adjustment, it is necessary to view the flame pattern

with the variable output control knob at its highest setting (turn fully clockwise). Allow the unit to operate for 10 minutes enabling the entire unit to reach temperature and for the flame pattern to stabilize. The flame pattern should be similar to the one shown in Figure 11. There are several guidelines to aid in determining if the flame pattern is correct:

1. The flame should not be dirty, smoky, sooty, or lick the top of the stove.
2. The flame should not rise off the TEK burner; this is called "lifting".
3. Flames should not impinge heavily on the log set. They should "fit" through the pre-formed spaces designed in the log set.



Figure 11: Typical flame appearance

ROUTINE MAINTENANCE AND CARE

The Tribute DV requires minimal routine maintenance and care. It should always be cool and off when being cleaned, or serviced. Once a year, the unit, and venting system should be inspected by qualified service personnel to insure that they are clean, free of obstruction, safe, and in good working order. If service or maintenance is required, qualified service personnel should perform it.

WARNING: DO NOT SUBSTITUTE MATERIALS FOR REPLACEMENT PARTS, OR FOR INFORMATION ABOUT PARTS OR SERVICE, CONTACT YOUR LOCAL HEARTHSTONE DEALER.

CLEANING THE UNIT

WARNING: DO NOT CLEAN THE UNIT WHEN HOT.

The unit should receive regular cleaning on, under, and around the stove to prevent the buildup of dust and lint. The exterior surfaces of the unit can be cleaned using soap, water, and a soft cloth. **Do not** use abrasive or chemical cleaners and take care not to scratch the glass or enamel finish (if so equipped) when cleaning the unit. The use of chemical wax based cleaners or polishes are not recommended due to the potential for discoloration of the stones, castings or enamel when the residues of the cleaners or polishes are exposed to heat. Excessive buildup of dust, spider webs, or room air contamination may cause odors when the stove is hot.

FIREBOX, PILOT, & BURNER ASSEMBLY

The firebox requires periodic cleaning to prevent the accumulation of dust, lint, and other debris. To clean the firebox, set the thermostat to the "OFF" position, and turn off the gas at the gas control valve. When the unit is cool, open the front door, and remove the front cast and glass assembly. Carefully remove the decorative log set, taking care not to damage the logs or chip the enamel cast iron. Clean the firebox and TEK burner, and carefully vacuum the entire surface of the log set. Thoroughly vacuum the ports (holes) along the top of the TEK burner, and the pilot assembly.

With the decorative logs out of the firebox, re-install the glass assembly and front cast. Briefly light the unit according to the lighting instructions described on page 22. Check to insure a proper flame is

burning from each burner port. The pilot flame should be large enough to engulf the thermopile and thermocouple as shown in Figure 10.

NOTE: Do not operate the unit for more than 1-2 minutes without the log set in place. Turn the unit off by setting the thermostat to "OFF", and turning the gas control valve off. Allow the unit to cool.

Check and clean any burner ports that are not burning, or not burning properly. Clean burner ports using a soft brush or vacuum cleaner. If the pilot flame height needs adjustment, it should be adjusted by qualified service personnel as described on page 24.

Complete the cleaning procedure by carefully placing the log set within the firebox as described on page 20. Re-install the glass assembly and front cast. Turn on the gas, light the unit and check for proper operation. Flame patterns should look similar to the flames in Figure 11. Regularly check to insure the area around the Tribute DV is kept free from combustible materials, gasoline, and other flammable vapors and liquids. Check that the flow of combustion and ventilation air is not obstructed.

REPLACE THE GLASS GASKET AS NEEDED

Your Tribute DV uses a 3/4" tape-style fiberglass gasket to make a tight seal between the doorframe and the firebox. In time, the gasket can become brittle and compressed and should be replaced. New gasket material is available from your Authorized Hearthstone Dealer. Protect your hands with work gloves, and wash up later.

1. Allow the Tribute DV to cool completely.
2. Remove the front cast and glass frame as described in the *Log Placement* section.
3. Using a 1/8" drill bit drill out the rivet in the top center of the glass frame. This will allow the glass to free up from the steel.
4. Remove the existing gasket by grasping one end and pulling firmly. Clean the remaining adhesive on the glass off with warm soapy water. Let dry.
5. Determine the correct length of the appropriate-sized gasket by wrapping it around in the glass.

Allow an extra 1 to 2" (25-50mm), and mark the spot to be cut.

6. Cut the gasket at the marked spot with a utility knife.
7. Starting at one end, pull the paper off the back of the gasket and center the gasket over the glass. Continue around the glass until you meet up where you started. Do not overlap the gasket ends or leave ends with ragged edges.
8. Firmly and evenly, press the gasket to seat it in its channel.
9. Sandwich the glass within the glass frame and glass gasket clip.
10. Using a 1/8"x1/8" rivet, reattach the glass gasket clip to the glass frame

GLASS CLEANING

As fuel gas contains some impurities; it will be necessary to clean the inside of the glass

occasionally. Do not use abrasive cleaners. Scratching the glass will weaken the integrity of the glass. **Do not clean the glass when hot!** Allow the glass to cool and apply a mild window cleaning fluid. Special gas appliance window cleaner is available from your local Hearthstone dealer.

 **WARNING: DO NOT OPERATE THIS APPLIANCE WITH THE GLASS PANEL REMOVED, CRACKED, OR BROKEN. DO NOT SUBJECT THE DOOR TO ABUSE, SUCH AS STRIKING OR SLAMMING SHUT. REPLACEMENT OF THE GLASS PANEL SHOULD BE DONE BY A LICENSED OR QUALIFIED SERVICE PERSON.**

VENTING

The venting system must receive a periodic examination by a qualified agency. If the vent-air system is disassembled for any reason, re-install per the instructions provided in the venting section of this manual, being sure to reassemble and reseal the venting properly.

PARTS LIST

Part No.	Description	Part No.	Description
2010-210	FOOT	7211-580	LOG: CENTER BOTTOM
2010-505	BOTTOM	7211-581	LOG: CENTER REAR
2010-520	COLUMN	7211-582	LOG: LEFT BOTTOM
2010-530	FRONT	7211-583	LOG: LEFT UPPER
2010-532	BAFFLE	7211-584	LOG: RIGHT SIDE
2010-535	HEAT EXCHANGER BASE	7211-517	CHARCOAL EMBERS 4OZ.
2010-537	HEAT EXCHANGER	7211-401	KNOB:EXTENSION,ON/OFF/PILOT,SIT (916188)
2010-540	LOWER TOP	7211-402	KNOB: EXTENSION,HI/LO,SIT (916189)
2010-545	UPPER TOP	7211-020	FITTING: 90deg,1/8"NPTx3/8"CMP(4054-06)
3030-046	GLASS	7200-506	THERMOSTAT: MILLIVOLT
3160-050	GASKET ; HEAT EXCHANGER	7210-103	IGNITOR:MILLIVOLT(#1244-61&1364-03)
3160-080	WINDOW TAPE 3/4" x 1/16"	5050-011	PILOT SHIELD DEFLECTOR, REAR
3160-150	HEAT EXCHANGER BASE GASKET	5050-012	PILOT SHIELD DEFLECTOR, FRONT
3160-152	PILOT GASKET	5050-013	PILOT SHIELD DEFLECTOR, TOP
3160-155	GASKET: EXIT	7200-248	BURNER ORIFICE NG #48
3160-157	GASKET: INLET	7210-103	IGNITOR:MILLIVOLT(#1244-61&1364-03)
3160-051	SHUTTER BOX GASKET	7211-163	PILOT ORIFICE NG .62 MM
3170-150	PLATINUM BRIGHT EMBERS	7211-310	VALVE: GAS,SIT,50% TD,NG,CHA/STG/TUC D&B
3300-580	SAFETY RATING LABEL	7211-370	BURNER: PILOT,CON TOP,3-WAY,NG, #199.724
3300-581	FUEL CONVERSION LABEL	7211-407	KNOB, EXTENSION CONTROL 1" ON-OFF (SIT)
5050-005	VALVE BRACKET	7211-404	KNOB, EXTENSION CONTROL 1" HI-LO (SIT #0916218)
5050-010	FIREBOX	7211-027	3/8" X 6"SS FLEX TUBE (STG/TUDOR)
5050-015	SHUTTER	7210-008	FITTING: 90deg,3/8"NPTx3/8"CMP(NUT&FER)
5050-017	SHUTTER BOX	7211-003	FITTING: STRAIGHT 1/4" NPT x 3/8"COMP
5050-020	BACK PANEL, LEFT		
5050-022	BACK PANEL, RIGHT		LP CONVERSION KIT
5050-030	HEAT SHIELD	7200-125	BURNER LP ORIFICE #56
5050-050	GLASS FRAME	7211-136	ORIFICE: PILOT,LP,0.35mm,CONVERT TOP,SIT
5050-060	RESTRICTOR	7211-313	REGULATOR: VALVE,LP,50% TURNDOWN,SIT
5120-078	DAMPER CONTROL		
5120-080	GLASS RETENTION CLIPS		ACCESSORIES
5120-082	GLASS PLATE CLIP	9050-41	STONE SET
5120-085	FAÇADE RETENTION CLIP, TUDOR	9055-41	REAR STONE SET
5210-3050	TIE-ROD 17"	90-69500	VIEWING SCREEN
5300-066	PIEZO, ON/OFF BRACKET	90-57501	BLOWER
5532-095	HEAT EXCHANGER HINGE PLATE		
5701-925H	STARTER COLLARS, CHA/SAN		
7211-238	TEK BURNER		

 **WARNING: DO NOT SUBSTITUTE MATERIALS.**

 **FOR REPLACEMENT PARTS, OR FOR INFORMATION ABOUT PARTS OR SERVICE, CONTACT YOUR AUTHORIZED HEARTHSTONE RETAILER. FOR THE NAME OF THE AUTHORIZED RETAILER NEAREST TO YOU, VISIT OUR WEBSITE WWW.HEARTHSTONESTOVES.COM, OR WRITE:**

HEARTHSTONE QUALITY HOME HEATING PRODUCTS, INC.
 317 Stafford Ave.
 Morrisville, Vermont 05661-8695
 E-Mail: inquiry@hearthstonestoves.com

TROUBLESHOOTING

Symptom	Possible Cause	Corrective Action
1. Pilot will not light.	<p>A. Insufficient gas pressure, air in the pilot line, or dirty or kinked gas line.</p> <p>B. Pilot orifice plugged.</p> <p>C. Defective or misaligned electrode at pilot.</p> <p>D. Defective igniter.</p> <p>E. After sitting for "off" season (summer), pilot assembly may be dirty.</p>	<p>A. Using the piezo sparker, try to light the pilot. If it will not light, check the inlet gas pressure.</p> <p>B. Clean or replace the pilot assembly.</p> <p>C. If a match lights a pilot, check the electrode gap and location. Should be a 1/8" gap in the flame area.</p> <p>D. Check for a good connection between igniter and electrode. Check wire insulation. If properly connected and no spark, replace igniter.</p> <p>E. Clean or replace the pilot assembly.</p>
2. Pilot will not stay lit after carefully following lighting instructions.	<p>A. Low or too high gas pressure</p> <p>B. Faulty connections.</p> <p>C. Defective thermocouple.</p> <p>D. Pilot dirty or plugged.</p>	<p>A. Check for proper inlet pressure for the gas being used.</p> <p>B. Measure voltage between valve body and solder connection on the rear of the valve (where the blue wire connects). It should be no less than 7 mV.</p> <p>C1. Ensure that the thermocouple connection at the gas valve is tight.</p> <p>C2. Check thermocouple output using milli-volt meter. Disconnect from valve and read voltage across wire ends. If the reading is less than 15 mV, replace the pilot assembly.</p> <p>C3. If burning NG, check pilot flame to see that it is impinging on the top of the thermocouple. Clean or replace pilot for maximum flame impingement.</p> <p>D. Clean or replace the pilot assembly.</p>

Symptom	Possible Cause	Corrective Action
3. Pilot burning, no gas to main burner, valve knob in the "ON" position, thermostat and/or on/off/t'stat switch in the "ON" position.	<p>A. Thermostat switch or wires defective.</p> <p>B. Thermopile may not be generating sufficient voltage.</p> <p>C. Plugged burner orifice.</p>	<p>A. Check thermostat/wiring for proper connections. Place jumper wire across terminals at thermostat. If burner comes on, replace defective thermostat. If not OK, place jumper across thermostat wires at gas valve. If burner comes on, tighten connections, or replace faulty wires.</p> <p>B. Check thermopile output, using a milli-volt meter. Take the readings across generator terminals of the gas valve. (TPTH and TP). Milli-volt reading should be greater than 325 mV. If not, replace the pilot assembly. If the meter reading is OK, but the burner does not come on, replace the gas valve.</p> <p>C. Remove and check burner orifice - clean or replace. Note: do not use any metal cleaning device, as this may damage the orifice.</p>
4. Pilot and burner come on, but go out after some warm-up.	<p>A. Inconsistent or insufficient flame on thermopile.</p> <p>B. Insufficient gas pressure.</p> <p>C. Excessive draft.</p>	<p>A. Adjust pilot flame size and assure that the flame is aimed directly at the thermopile.</p> <p>B. Check line pressure to ensure that the correct inlet pressure is present for the type of gas being used. If propane pressure is inconsistent, check for water condensation at the regulator.</p> <p>C. Check Restriction settings per this manual.</p>
5. Frequent pilot outage problem.	<p>A. Pilot flame may be too low or blowing, (high), causing the pilot safety to drop out.</p> <p>B. Excessive draft</p>	<p>A. Clean and/or adjust the pilot flame for maximum impingement on the thermopile and thermocouple.</p> <p>B. Check Restriction settings per this manual.</p>
6. Glass fogs	A. A normal result of gas combustion and cold glass.	A. After the heater has warmed up, the glass should clear.
7. Blue Flames	A. A normal result during the first 20 minutes.	<p>A. Flames should begin to turn more yellowish after 20 minutes of burning.</p> <p>B. If the blue color stays; adjust the air shutter for a proper burn.</p>

Symptom	Possible Cause	Corrective Action
<p>8. Floating flames, lazy ill-defined, quiet flames, which roll around, sometimes completely off of the port, sometimes with overly, yellow tips. Possible sooting. Usually accompanied by the odor of aldehydes.</p>	<p>A. Potentially dangerous incomplete combustion due to incorrect air to fuel ratio (lack of combustion air or excessive fuel delivery I.e. excessive gas pressure, overrating of appliance).</p> <p>B. Incorrect air intake/exhaust flow system. Causes may be:</p> <p>B1. Blocked burner. B2. Blocked primary air B3. Blocked secondary air inlets</p>	<p>A. Check the appliance input rate and reduce if necessary. The air intake/exhaust flow system may be too restrictive or blocked (the rate at which the exhaust leaves [draft] determines the rate at which the combustion air is delivered). Poor draft results in insufficient air delivery or a restricted exhaust. Correct air intake/exhaust flow system.</p> <p>B1. Clear ports. B2. Clear obstructions. B3. Clear obstructions.</p> <p>C. If gas pressures are correct and the flames stay the same, adjust the air shutter for a proper burn.</p>
<p>9. Burner flashback. Air-gas mixture ignites inside the burner near the orifice, usually creating a roaring noise like a blowtorch. The problem is an imbalance of gas flow velocity and burning speed pattern.</p>	<p>A. Excessive primary air.</p> <p>B. Burner input underrated.</p> <p>C. Valve leak if flashback occurs with burner valve in off position.</p> <p>D. Improper gas pipe size.</p>	<p>A. Adjust the air shutter for a proper burn.</p> <p>B. Check input rate. Check input pressure using a manometer. Confirm correct gas pressure at house meter or tank (call gas company). Confirm burner orifice size.</p> <p>C. Replace valve. If above corrections do not eliminate flashback, replace burner.</p> <p>D. Correct plumbing.</p>
<p>10. Delayed ignition (makes a sudden "whoosh" noise as the burner lights). This is a buildup of gas prior to ignition. This is more prevalent with propane (LP) fuel.</p>	<p>A. Incorrect air-to-fuel ratio.</p> <p>A1. Primary air incorrect.</p> <p>A2. Burner ports plugged.</p> <p>B. Improper log placement.</p>	<p>A1. Adjust the air shutter for a proper burn.</p> <p>A2. Open ports to allow for proper travel of flames.</p> <p>B. Reposition logs to eliminate interference with flame travel.</p>

RATING LABEL

MODEL # 8050-
SERIAL # 101001



MODEL NAME: TRIBUTE DIRECT VENT GAS FIREPLACE HEATER
LISTED: VENTED GAS FIREPLACE HEATER
TESTED TO: ANSI Z21.88-2002 CSA 2.33-M02, CAN/CSA-2.17-M91

CERTIFIED FOR CANADA/HOMOLOGUE POUR LE CANADA
ALSO FOR MOBILE HOME INSTALLATION

DO NOT OPERATE WITH GLASS REMOVED OR BROKEN.

FUEL TYPE:	■ NG	■ LP
INPUT RATING (Btu/hr) 0-2000 ft	18,000	17,500
INPUT RATING (Btu/hr) 0-4500 ft	18,000	17,500
ORIFICE SIZE (DMS) 0-2000 ft	48	56
ORIFICE SIZE (DMS) 0-4500 ft	48	56
MANIFOLD PRESSURE - LO SETTING (in. W.c./kpa)	1.2/0.3	3.3/0.8
MANIFOLD PRESSURE - HI SETTING (in. W.c./kpa)	3.5/0.87	10.0/2.48
INLET PRESSURE (in.w.c./kpa)	5.0/1.24	10.0/2.48
MINIMUM INPUT RATING (btu/hr)	10,600	10,400
MAXIMUM OUTPUT (btu/hr) 0-2000 ft	13,300	13,200

This appliance must be installed in accordance with the local codes, if any, if not; follow the National Fuel Gas Code, ANSI Z223.1 or Canadian Installation Codes, CAN/CSA-B149. (Installer l'appareil selon les codes ou réglemets locaux, ou, en l'absence de tels réglemets, selon les Codes d'installation CAN/CSA-B149.)

WARNING: Improper installation, adjustment, alteration, service or maintenance can cause injury or property damage. Refer to the owner's information manual provided with this appliance. For assistance nor additional information consult a qualified installer, service agency or the gas supplier. (AVERTISSEMENT: L'installation inconvenante, un ajustement, une modification, un service ou un entretien mal effectué peut causer des dommages matériels ou des blessures. avec cet appareil. Pour de l'assistance ou de l'information Référez au manuel d'information fourni supplémentaire, consulter un installateur qualifié, une agence de service ou le fournisseur de gaz.)

MINIMUM CLEARANCES TO COMBUSTIBLES

EDGE OF TOP TO: CEILING	9" / 229 mm
BACK OF STOVE TO: BACKWALL	2" / 50 mm
EDGE OF SIDE TO: SIDEWALL	2" / 50 mm
EDGE OF TOP TO DIAGONAL WALL	2" / 50mm

ELECTRICAL RATING:
115 VOLTS 60Hz, LESS THAN 1 A

Several Optional kits are available through HearthStone or your local HearthStone dealer. A blower assembly may be used (kit # 90-57501), two different remote controls (kit #90-56912 & kit #90-56914), and an optional viewing screen is also available (90-69500).

This appliance is only for use with the type of gas indicated on this rating plate and may be installed in an aftermarket, permanently located, manufactured (mobile) home where not prohibited by local codes. See owner's manual for details. This appliance is not convertible for use with other gases, unless a certified kit is used. If the vent air intake system is disassembled for any reason, reinstall per the instructions provided with the initial instructions. This vented gas fireplace heater is not for use with air filters. **Caution:** Do not operate the appliance with glass removed, cracked, or broken. Replacement of the glass should be done by a licensed or qualified service person. (AVERTISSEMENT: Ne pas utiliser l'appareil si le panneau frontal en verre n'est pas en place, est craqué ou brisé. Confiez le remplacement du panneau à un technicien agréé.)

VENTED GAS FIREPLACE HEATER - NOT FOR USE WITH SOLID FUEL.



MANUFACTURED BY: HearthStone, MORRISVILLE, VERMONT 05661

Date of Manufacture

2006 2007 2008 Jan Feb Mar Apr May Jun Jul Aug Sep Oct Nov Dec
 ■ ■ ■ ■ ■ ■ ■ ■ ■ ■ ■ ■ ■ ■ ■

DO NOT REMOVE OR COVER THIS LABEL

MADE IN USA

3300-580

WARRANTY REGISTRATION

The Original Purchaser can complete their warranty registration on our website at www.hearthstonestoves.com, or send a completed and signed Warranty Registration Form, which is enclosed in the Gas Stove warranty packet, to the following address:

Hearthstone Quality Home Heating Products, Inc.
Warranty Department
317 Stafford Avenue
Morrisville, VT 05661

 **NOTE: SENDING IN THE SIGNED WARRANTY REGISTRATION FORM IS *NOT REQUIRED* AS A CONDITION OF WARRANTY COVERAGE OR HEARTHSTONE'S PERFORMANCE.**

Notes: